

## Steca Solarix PLI

Installation and operating instructions



# Table of Contents

<b>About this manual .....</b>	<b>2</b>
Purpose .....	2
Scope .....	2
Keywords and symbols.....	2
<b>General safety instructions.....</b>	<b>2</b>
<b>Introduction .....</b>	<b>4</b>
Features.....	4
Basic System Architecture .....	4
Product Overview .....	5
<b>Installation.....</b>	<b>6</b>
Unpacking and Inspection .....	6
Preparation.....	6
Mounting the Unit.....	6
Residual current circuit breaker (RCD) .....	7
Battery Connection.....	8
AC Input / Output Connection .....	9
PV Connection.....	12
PV Module Selection .....	12
Final Assembly.....	14
Optional Accessories.....	14
Dry Contact Signal .....	14
<b>Operation .....</b>	<b>16</b>
Power ON/OFF .....	16
Display and Control Panel .....	16
LC-Display Icons .....	17
Configuration .....	20
Display Setting.....	28
Operating Mode Description.....	31
Recommendation for generator as AC input source .....	32
Internal Fan.....	32
Fault Reference Code .....	32
Warning Reference Code .....	33
<b>Battery Equalisation .....</b>	<b>34</b>
<b>Specifications .....</b>	<b>35</b>
Line Mode Specifications .....	35
Inverter / Battery Mode Specifications .....	36
Charge Mode Specifications .....	37
General Specifications.....	39
<b>Troubleshooting .....</b>	<b>39</b>
Shutdown procedure.....	39
Maintenance .....	40
Troubleshooting .....	40
<b>Guarantee Conditions .....</b>	<b>42</b>
<b>Exclusion of Liability.....</b>	<b>42</b>
<b>Contact .....</b>	<b>42</b>

# About this manual

## Purpose

This manual describes the assembly, installation, operation and troubleshooting of this unit (also referred to as “inverter” throughout this manual or “PLI 5000-48” for the Solarix PLI 5000-48, “PLI 2400-24” for the Solarix PLI 2400-24, or “PLI 1000-12” for the Solarix PLI 1000-12 models). Please read this manual carefully before installation and operation. Keep this manual for future reference.

## Scope

This manual provides safety and installation guidelines as well as information on wiring and operation.

## Keywords and symbols

These keywords are used in this manual with the following meanings:

Keyword	Description
<b>DANGER</b>	Immediate danger of death or serious bodily injury
<b>WARNING</b>	Possible danger of death or serious bodily injury
<b>CAUTION</b>	Possible danger of light or medium bodily injury or damage to equipment



This symbol indicates a warning or danger, pay particular attention to these sections.

## General safety instructions



**WARNING: This chapter contains important safety and operating instructions. Read and keep this manual for future reference.**

1. This document is part of the product.
2. **CAUTION** Only qualified service professionals may perform the installation work described in this manual.
3. Before using the unit, read all instructions and cautionary markings on the unit, the batteries and all appropriate sections of this manual.
4. **CAUTION** To reduce risk of injury, charge only rechargeable deep-cycle lead-acid batteries with liquid electrolyte, AGM or gel. Other types of batteries may burst, causing personal injury and damage, if they are not approved by KATEK Memmingen GmbH. Use only batteries with 48, 24 or 12 VDC nominal voltage with the PLI 5000-48, PLI 2400-24 and PLI 1000-12, respectively.
5. Do not disassemble the unit, doing so may cause damage to the unit, personal injury and leads to a total loss of warranty. Contact your dealer when service or repair is required. Incorrect re-assembly may result in a risk of electric shock or fire.
6. To reduce risk of electric shock, disconnect all wirings before attempting any maintenance or cleaning. Turning off the unit will not reduce this risk.
7. **CAUTION** Never charge a damaged or frozen battery.
8. **CAUTION** For optimum operation of this unit, please follow the required specification to select appropriate cable sizes. Failure to do so may cause damage.

- 
9. Be very cautious when working with metal tools on or around batteries. A potential risk exists in short-circuiting batteries or other electrical parts, potentially causing an explosion or fire. Use only insulated tools.
  10. Please strictly follow installation procedure when connecting or disconnecting AC or DC terminals. Please refer to the "**Installation**" section of this manual for the details.
  11. **WARNING** Ensure that all cables, particularly the AC input, AC output, photovoltaic (PV) and battery cables are seated properly in their contacts and tightened correctly. No cable insulation may protrude into the corresponding cable terminals. Any materials other than the cable / cable lug / ring terminal inserted into the terminals could cause excessive heating, damage and / or fire.
  12. Make sure to use a battery fuse as close as possible to the battery terminal with a rating of 200 A DC for the PLI 1000-12 or 250 A DC for the other units as over-current protection for the battery and battery cables. The fuse must be able to reliably protect the battery cables from short-circuit or overload.
  13. **WARNING** This inverter is required to be connected to a permanent grounded wiring system via the appropriate terminals. Failure to do so may cause serious personal injury. Be sure to comply with local requirements and regulations when installing this inverter.
  14. Never allow the AC output and DC input to be short-circuited. Do NOT connect to the AC mains when the DC input short circuits.
  15. If one of the following components is damaged immediately take the device out of operation and disconnect it from the AC mains, battery and PV modules: the device itself (not functioning, visible damage, smoke, penetration of liquid etc.), connected cables or solar modules.  
Do not switch the system on again before the device has been repaired by a dealer or the manufacturer, damaged cables or solar modules have been repaired by a technical specialist.
  16. Any use of this product aside from its intended purpose as described in this manual could lead to damage and/or serious personal injury. Opening any part of the device apart from the bottom cover as described in this manual will void the warranty and can lead to damage and/or serious personal injury.
  17. Only for indoor use, pollution degree 2. Not for use in workshops or other high-dust environments without counter-measures.
  18. **CAUTION** Heavy device. Take care when lifting the device to avoid injury.

## Introduction

This is a multi-function inverter/charger, combining functions of an off-grid inverter, a MPPT solar charger, AC transfer from an AC source to AC loads, and a battery charger from an AC source to offer an uninterruptible power supply with a compact size. Its comprehensive LC-display offers user-configurable and easily-accessible button configuration as well as a readout of relevant data.

## Features

- Pure sine wave inverter
- Built-in MPPT solar charge controller
- Configurable AC input voltage range limit for home appliances or personal computers
- Configurable battery charging current based on applications via LCD setting
- Configurable AC / solar charger priority via LCD setting
- Compatible with AC voltage from generator power
- Optional secondary power source in case of PV-failure via a generator connection
- Bipolar disconnection from the AC input in inverter mode, grid injection is not technically possible
- Overload, over-temperature and short-circuit protection
- Smart multi-stage battery charger with optional equalisation for optimised battery performance
- Up to nine inverters can be connected in parallel or as a 3-phase system with the optional Parallel Kit for Solarix PLI accessory (only Solarix PLI 5000-48 or Solarix PLI 2400-24, one kit required per inverter)

## Basic System Architecture

The following illustration shows the basic application for this unit. It also includes the following devices to have a complete running system: battery, generator or utility (if both are used in a single system an external source-selector is required as shown in *Fig. 1*), and / or PV modules.

Consult with your system integrator for other possible system architectures depending on your requirements.

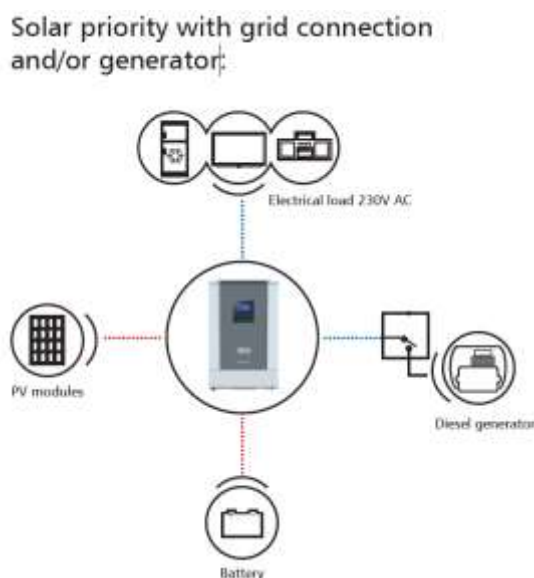

Figure 1: Hybrid power system

## Product Overview

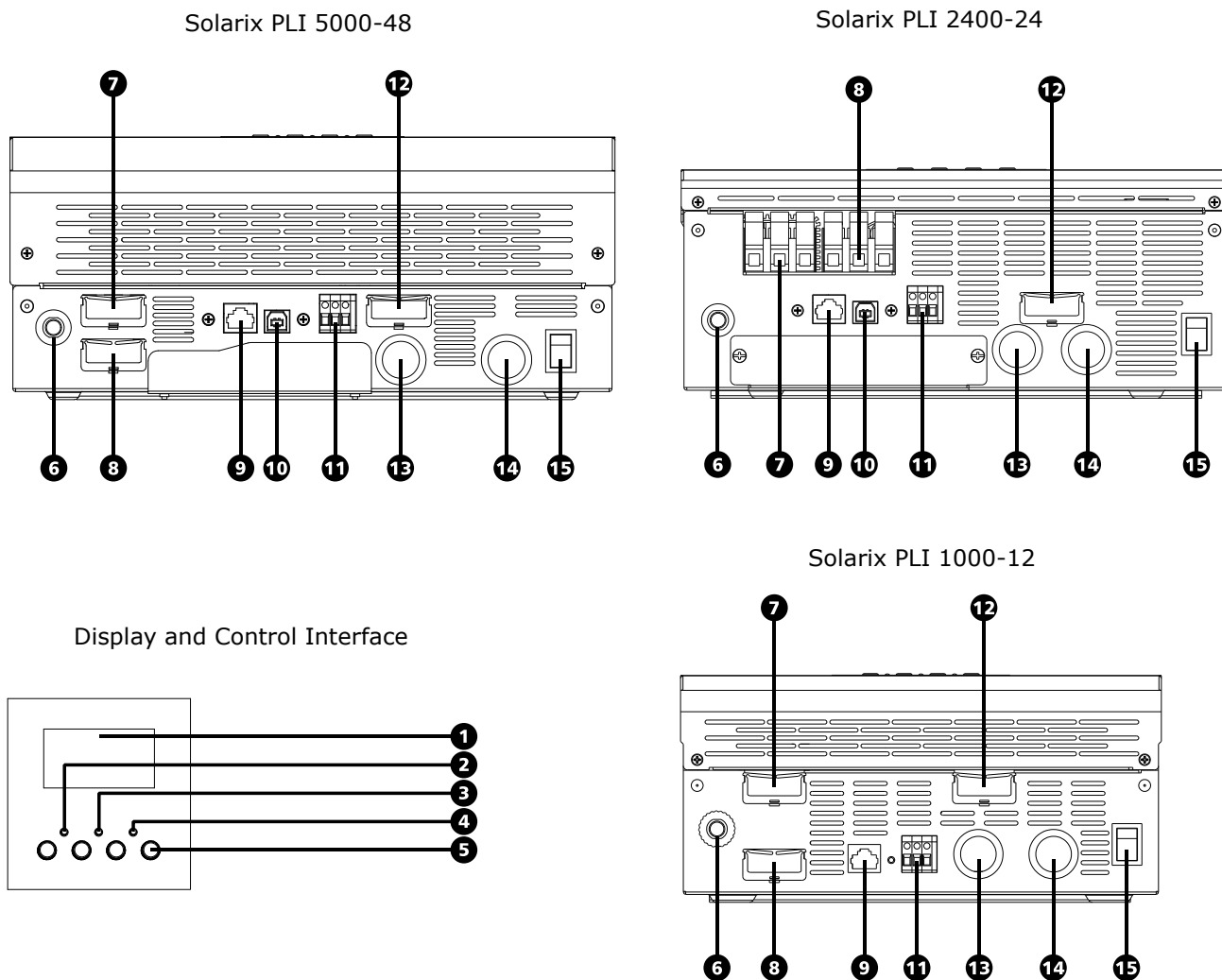

Figure 2: Device overview

1. LCD display
2. Status indicator for line / inverter mode
3. Charging indicator
4. Fault indicator
5. Function buttons (ESC, UP, DOWN, ENTER)
6. Circuit breaker
7. AC input
8. AC output
9. RS-232 communication port
10. USB communication port (not available for PLI 1000-12)
11. Signal contact
12. PV input
13. Battery connection (positive)
14. Battery connection (negative)
15. Power on/off switch for the inverter unit (the charge controller will charge the battery if solar power and voltage is available and sufficient, regardless of the position of this power switch)

# Installation

## Unpacking and Inspection

Before installation, please inspect the unit. Be sure that nothing inside the package is damaged. Included items:

- The inverter unit
- Installation and operating instructions
- RS-232 communication cable
- USB cable
- Ring terminal (3x)

## Preparation

Before connecting all wirings, please take off bottom cover by removing the two screws shown in *Fig. 3*.

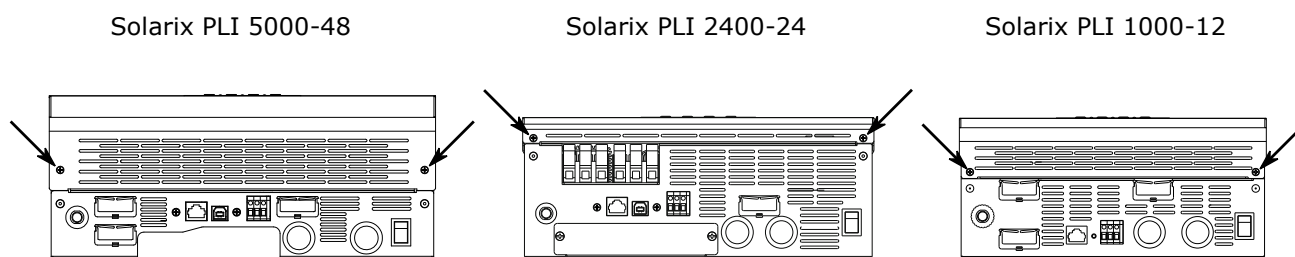



Figure 3: Screw location on bottom cover

## Mounting the Unit

	<p><b>WARNING: Suitable for mounting on concrete or other non-combustible surface only. This is a class A product. In a domestic environment this product may cause radio interference in which case the user may be required to take adequate measures.</b></p>
---	--

Consider the following points before selecting where to install:

- Do not mount the inverter directly above batteries, as corrosive battery gases can damage the inverter
- Mount on a solid, non-flammable surface
- Install this inverter at eye level in order to allow the LCD display to be read at all times
- The ambient temperature should be between 0 °C and 55 °C. The place of installation shall have natural ventilation, low dust and humidity is less than 90%.

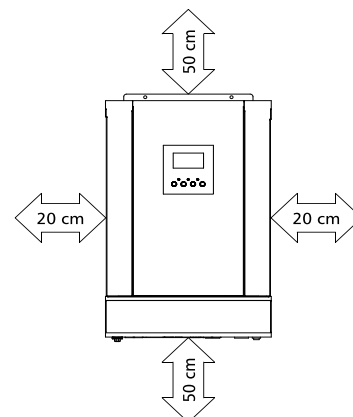
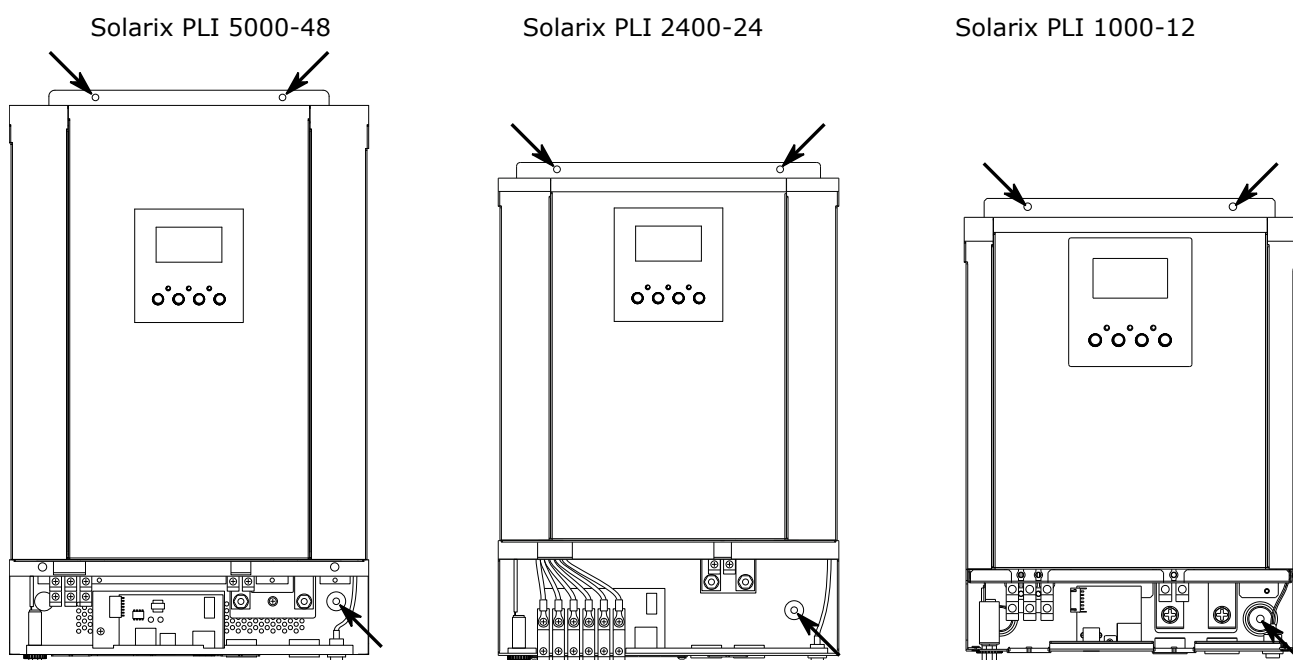

Figure 4: Minimum distance to walls and other objects

- The recommended installation position is adhered to the wall vertically. Please beware that due to fan noise it is recommended to install the unit in a closed room.
- Be sure to keep other objects and surfaces at least as far from the installed inverter as shown in *Figure 4* to guarantee sufficient heat dissipation and to have enough space for the removal of any wires

Fix the unit to the wall by using three screws (not included) in the screw holes pictured below in *Figure 5*. Be sure to take precautions such as wall plugs, ensuring that the inverter's weight can be safely held by the wall and screws.



*Figure 5: Mounting screw holes*

## Residual current circuit breaker (RCD)

Due to its design, the inverter cannot cause a DC fault current. Therefore, the installation of a Residual Current Device (RCD) is not necessary. If local installation regulations or the power supply company require the installation of an external residual current device (RCD) in the AC connection line, a type A residual current device (RCD) is sufficient according to IEC 62109-1. The tripping current should be rated at least 100 mA or higher. If several inverters are installed in a system, a corresponding earth-leakage circuit breaker (RCD) must be installed for each individual inverter.



## Battery Connection



**WARNING: All wiring must be performed by qualified personnel according to local regulations.**

**Shock Hazard. Installation must be performed with care due to high battery voltage in series.**

**It is very important for system safety and efficient operation to use appropriate cable cross-sections for the battery connection. The recommended cross-section for the battery connection is 50 mm<sup>2</sup> for the PLI 5000-48 and PLI 2400-24, and 25 mm<sup>2</sup> for the PLI 1000-12 (at 3 metres cable length). Keep the cables between the inverter and battery as short as possible, preferably  $\leq 3$  metres. Failure to tighten connections adequately could lead to overheating or fire.**

**CAUTION: To ensure safe operation and regulation compliance, it is necessary to install a separate DC fuse or circuit breaker device between battery and inverter, as close as possible to the battery terminal. The recommended fuse or circuit breaker rating is 250 ADC for the PLI 5000-48 and PLI 2400-24, and 200 ADC for the PLI 1000-12, be sure to adhere to your local regulations.**

**Do not place anything between the flat part of the inverter terminal and the ring terminal. Otherwise, overheating and / or fire may occur.**

**Do not apply any anti-oxidant or other substances on the terminals before the terminals are connected tightly.**

Follow the steps below to connect the battery to the inverter:

1. Ensure the ON/OFF power button is set to OFF (see chapter "**Power ON/OFF**").
2. Open the circuit breaker or remove the fuse near the battery terminal.
3. Remove 15 mm of insulation on the inverter side of the battery cable from both the positive and negative lines.
4. Assemble the included battery ring terminal by crimping it to the battery cables on the inverter side, make sure that none of the insulation interferes with the ring terminal!
5. Connect all battery cells or packs as required to reach 48, 24 or 12 VDC nominal voltage for the PLI 5000-48, PLI 2400-24 and PLI 1000-12 respectively. It is highly recommended to use at least a 200 Ah capacity battery bank.
6. Connect the battery-side of the cable to the battery appropriately, ensuring a tight and reliable fit.
7. Remove the nut on the positive and negative battery terminals of the inverter.
8. Insert the ring terminal of the battery cable flatly into the battery connector screws of the inverter, then tighten the nuts / screws with a torque of 2 - 3 Nm (see *Figure 6*). Make sure the polarity at both the battery and the inverter is correct and the ring terminals are tightly screwed to the battery terminals, ensuring a good electrical connection.
9. Make sure to install an external strain relief on the battery cables.
10. Do not insert the battery fuse or turn on the battery circuit breaker yet!

Solarix PLI 5000-48

Solarix PLI 2400-24

Solarix PLI 1000-12

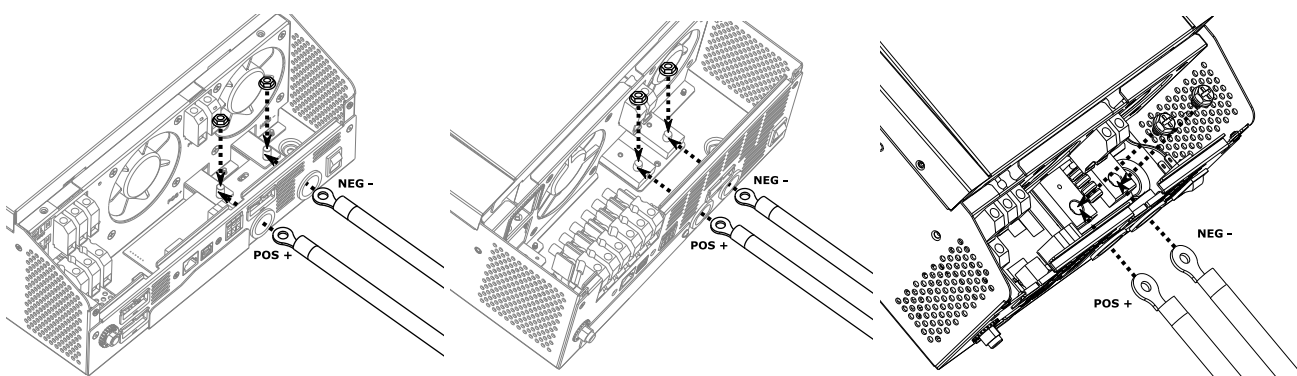

Figure 6: Battery cable connection

**CAUTION:** An inverter with storage connections will need to provide a means for temperature compensation of the battery charge voltages. This is particularly important for use with lead acid batteries in warm climates, to avoid damage to battery banks by overcharging in hot weather, and related hazards due to release of hydrogen gas and cell rupture.

The Steca Solarix PLI does not include a connection terminal for a remote battery temperature sensor. If installing a Steca Solarix PLI with lead acid batteries please check with your local retailer or manufacturer for advice regarding charge settings.

## AC Input / Output Connection



**DANGER:** Be sure that AC power source is disconnected before attempting to hardwire it to the unit.



**WARNING:** All wiring must be performed by qualified personnel according to local regulations.

It is very important for system safety and efficient operation to use appropriate cable cross-sections for the AC connection. The recommended cross-section for the AC connection is 6 mm<sup>2</sup>, 2.5 mm<sup>2</sup> is sufficient for the PLI 1000-12. Failure to tighten connections adequately could lead to overheating or fire.

**CAUTION:** Before connecting to the AC input power source, install a separate AC breaker between the inverter and AC input power source and turn it off. This will ensure the inverter can be securely disconnected during maintenance and is protected from over-current from the AC input. The recommended AC breaker rating is 40 A, 30 A or 10 A for the PLI 5000-48, PLI 2400-24 and PLI 1000-12, respectively. Follow your local regulations.

**CAUTION:** Do **NOT** use the public power grid as AC input power source. This does not reflect the intended use of the inverter. Use local generators only.

**There are two terminal blocks, one marked "AC INPUT" and the other "AC OUTPUT". Do NOT mix the input and output connectors!**

**Connect a single inverter to only one phase (L and N). Also make sure never to reverse L and N connections.**

**Some appliances such as air conditioners require at least 2 - 3 minutes to restart after a loss of power to have enough time for the refrigerant gas to settle. If a power shortage occurs and power is re-supplied in a short time, this may cause damage to such appliances. To prevent this kind of damage, please check the appliance manufacturer guidelines, the appliance may be equipped with a time-delay function during installation. If this is disregarded, this inverter may trigger an overload fault and cut off output to protect your appliances, potentially nonetheless causing internal damage to the appliance.**

**It is highly recommended to use a surge protection device (SPD) on the AC input of the inverter if the AC input is used. The SPD must have a clamping voltage at or below 300 VAC.**

Follow the steps below to connect the AC input (optional) and AC output to the inverter:

1. Before making AC input/output connection, ensure the battery DC circuit breaker is open and/or the battery fuse is removed, thus disconnecting the battery.
2. Ensure the AC circuit breaker is open so that no conductors have voltage.
3. Remove 10 mm of insulation on the inverter side of the PE (protective earth) conductors for both AC input and AC output. Remove 7 mm of insulation on the inverter side of the L (phase) and N (neutral) conductors for both AC input and AC output.
4. Connect the PE (⚡ - protective earth) cable of the AC input (*Figure 7*) to the corresponding terminal on the inverter and connect the PE (⚡ - protective earth) conductor of the AC output (*Figure 8*) to the corresponding terminal on the inverter. Tighten the terminal clamps with a torque of 1.2 Nm.
5. Connect the L (phase) and N (neutral) conductors to the respective AC input (*Figure 7*) and AC output (*Figure 8*) terminals. Tighten the terminal clamps with a torque of 1.2 Nm.
6. Make sure to install a strain relief on the AC input and AC output cables.
7. Make sure all connections are secure and tightened correctly, ensuring a good electrical connection.

Solarix PLI 5000-48 & Solarix PLI 1000-12

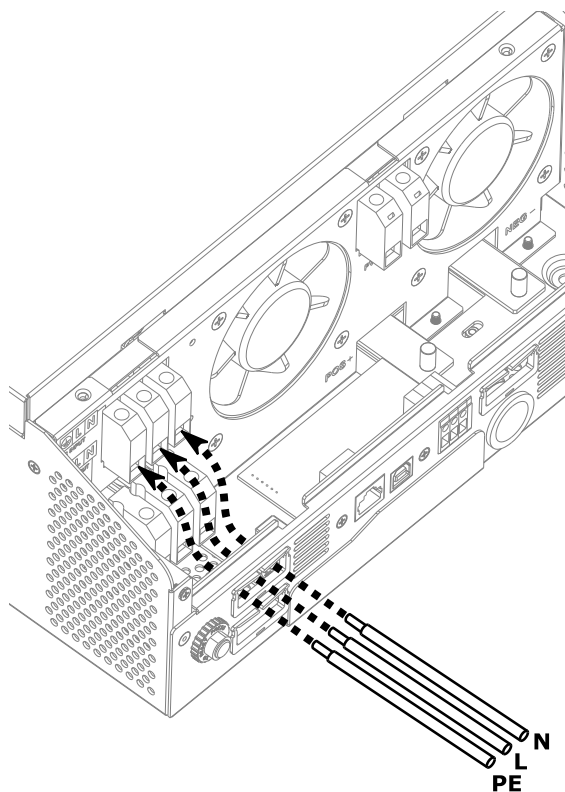

Solarix PLI 2400-24

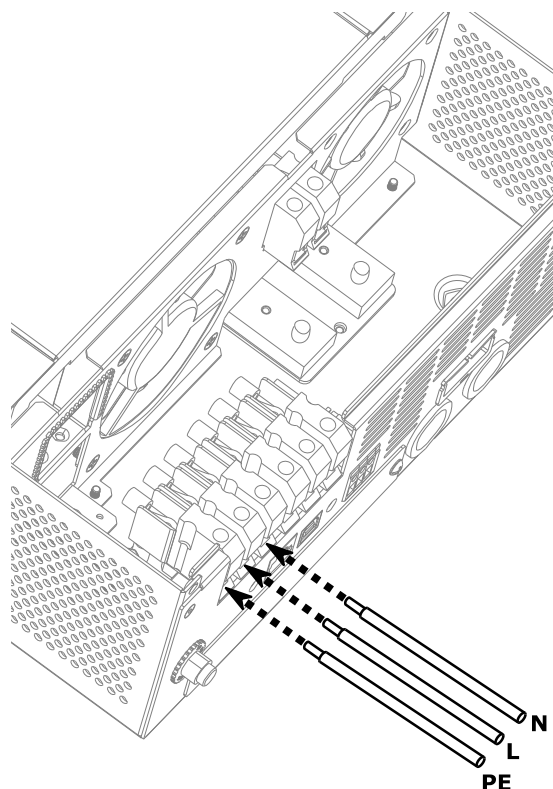
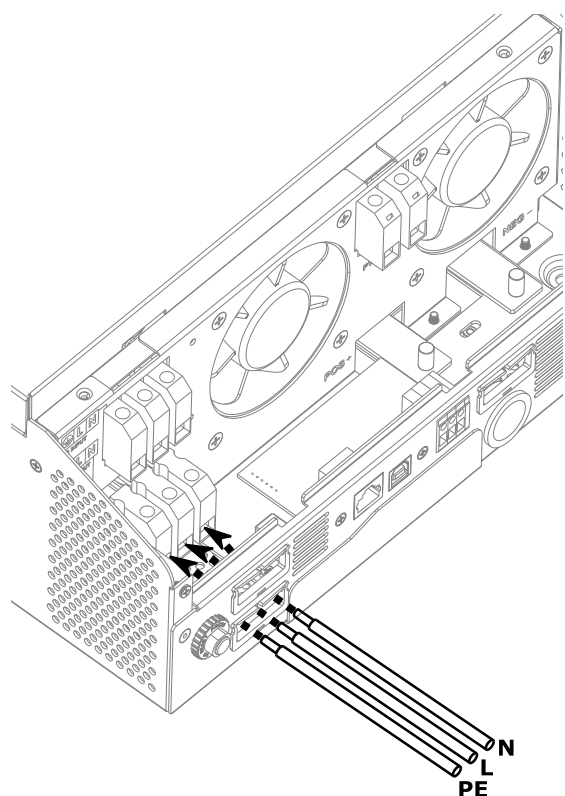

Figure 7: AC input conductor connection

Solarix PLI 5000-48 & Solarix PLI 1000-12



Solarix PLI 2400-24

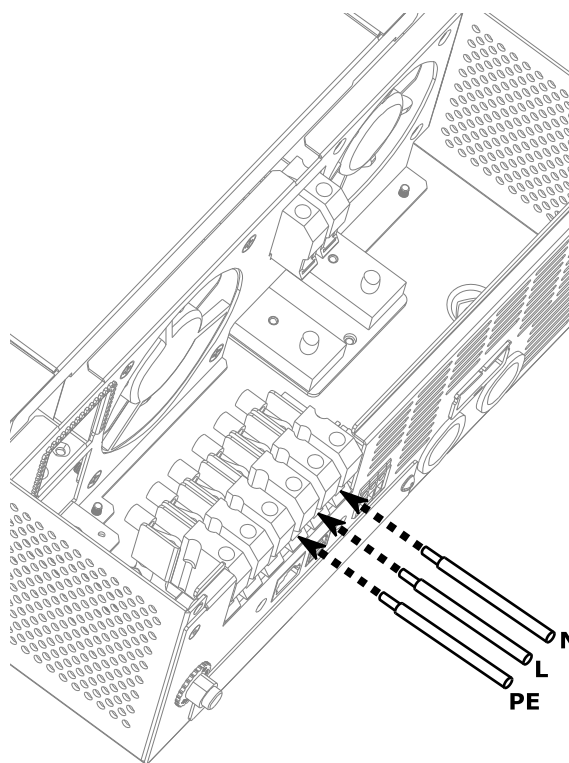

Figure 8: AC output conductor connection

## PV Connection



**WARNING:** All wiring must be performed by qualified personnel according to local regulations.

It is very important for system safety and efficient operation to use appropriate cable cross-sections for the PV connection. The recommended cross-section for the PV connection is 12 mm<sup>2</sup> or 6 mm<sup>2</sup> for the PLI 5000-48 or PLI 2400-24 / PLI 1000-12, respectively. Failure to tighten connections adequately could lead to overheating or fire.

**CAUTION:** Before connecting to the PV input, install a separate DC breaker or DC disconnecting switch with a recommended rating of at least 80 ADC (PLI 5000-48) or 40 ADC (PLI 2400-24 and PLI 1000-12) between the inverter and PV modules and turn it off. This will ensure the inverter can be securely disconnected during maintenance.

It is highly recommended to use a surge protection device (SPD) on the PV input of the inverter, if the PV input is used, to protect the PV input from over-voltage. The SPD must have a clamping voltage at or below 160 VDC (PLI 5000-48) or 100 VDC (PLI 2400-24 and PLI 1000-12), and above the maximum open-circuit PV voltage under all temperature conditions at the installation site.

## PV Module Selection

When selecting proper PV modules, please be sure to consider the following parameters:

1. The open-circuit voltage (Voc) of the PV array at the lowest temperatures present throughout the year in the installation location does not exceed the maximum PV open-circuit voltage of the PV input of the inverter.
2. The MPP voltage (Vmpp) of the PV array must be higher than the minimum PV MPP voltage of the PV input of the inverter.
3. The total power in watt-peak (Wp) of the PV array should not exceed 1.2x the nominal PV charging power of the inverter.

Follow the steps below to connect the PV input (optional) to the inverter:

1. Ensure the circuit breaker between the PV modules and the inverter side of the PV cables is open so that there is no voltage on the PV cables before the connection.
2. Remove 10 mm of insulation on the inverter side of the battery cable from both the positive and negative PV cables.
3. Check the correct polarity of the connection cable from the PV modules and PV input connectors on the inverter.
4. Connect the positive / negative cables from the PV array to the respective PV terminals on the inverter (*Figure 9*). Tighten the terminal clamps with a torque of 1.2 Nm
5. Make sure the connections are secure and tightened correctly, ensuring a good electrical connection.

Solarix PLI 5000-48 & Solarix PLI 1000-12

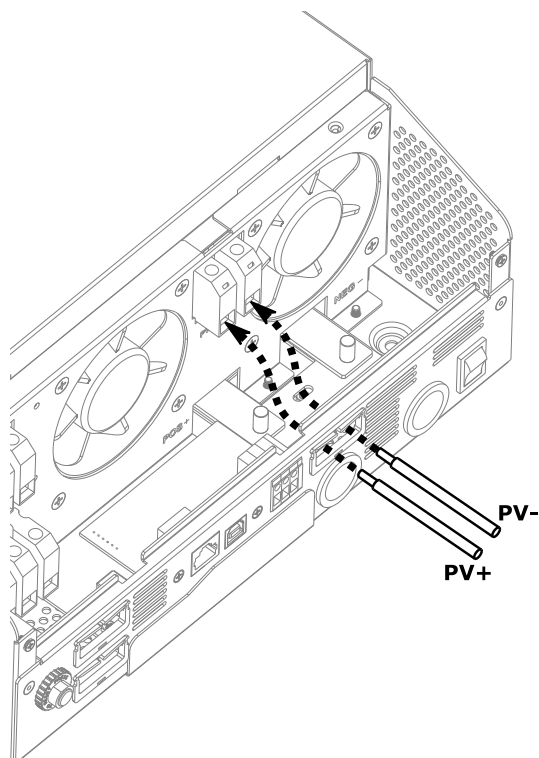

Solarix PLI 2400-24

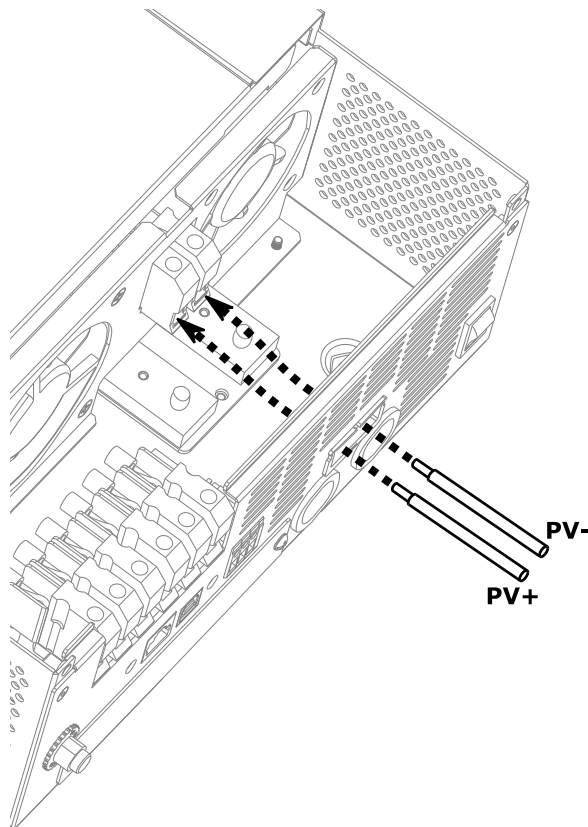
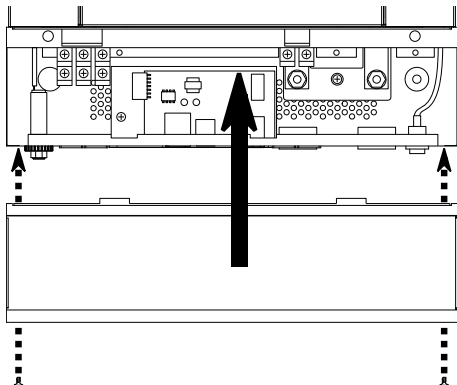

Figure 9: PV array cable connection

## Final Assembly

After connecting all wirings, please slide the bottom cover back onto the bottom of the inverter and fasten the two screws as shown below (Figure 10).

Solarix PLI 5000-48 & Solarix PLI 1000-12



Solarix PLI 2400-24

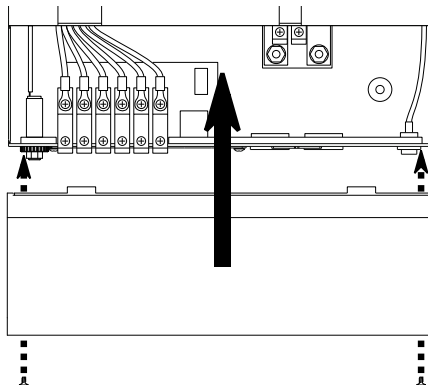

Figure 10: Closing the bottom cover

Now the fuse/circuit breaker of the battery can be inserted/closed to electrically connect the inverter to the battery. Next the AC input circuit breaker can be closed, then the AC output breaker and finally the fuse/circuit breaker of the PV connection.

## Optional Accessories

The Solarix PLI 5000-48 and Solarix PLI 2400-24 can be used with up to nine identical inverters in a single synchronised phase, or setup as a 3-phase system. This allows systems with up to 45 kW or 21.6 kW of synchronised AC power for the Solarix PLI 5000-48 or Solarix PLI 2400-24, respectively. To enable this functionality, the Steca Parallel Kit for Solarix PLI is required (sold separately). One kit is required for each inverter to be interconnected. For further details consult the Parallel Kit manual.

## Dry Contact Signal

There is a dry contact (up to 3 A / 250 V AC or 3 A / 30 V DC) available on the bottom panel. It has two possible functions:

1. When program 38 is set to "disable" (see chapter "**Configuration**"), it can be used to deliver a signal to an external device (such as an AC generator) when battery voltage reaches its warning level.
2. When program 38 is set to "enable" (only available for Solarix PLI 5000-48) and the unit is working in battery / inverter mode, it can be used to trigger an external grounding box (not included). This grounding box can then connect neutral (N) and protective earth (PE) grounding of the AC output together.

Function 2 is useful for installations where the AC input has a TN-C-S or TN-S grounding scheme, so where PE and N are separate and typically a residual current device (RCD) is used for safety from electric shock.

In order for an RCD on the AC output to function, there must be a bridge between N and PE before it. This is the case in a TN-C-S or TN-S grounding scheme. **As a safety measure, when the inverter is working in off-grid / inverter mode, so when both the AC input N and L are disconnected by the internal by-pass / transfer relay, a connection between N and PE is automatically made in the PLI 5000-48 and PLI 2400-24 inverters.** With program 38 enabled, an external grounding box controlled by the dry contact can bridge N and PE only in off-grid / inverter mode and release the bridge in line mode, as an additional N to PE bridge.

**Grounding is safety-relevant and should only be done by qualified personnel. Make sure local regulations are adhered to.**

When program 38 is set to "disable" (default setting for PLI 5000-48 and PLI 1000-12, only setting for PLI 2400-24):

Inverter unit status	Condition		Dry contact port:		
			NC & C	NO & C	
Power Off	Unit is off and no output is powered.		Closed	Open	
Power On	Output is powered from AC input.		Closed	Open	
	Output is powered from Battery or Solar.	Program 01 set to "Utility"	Battery voltage < Low DC warning voltage	Open	Closed
			Battery voltage > value set in Program 13 or battery charging reaches floating stage	Closed	Open
	Program 01 is set to "SBU" or "Solar first"	Battery voltage < value set in Program 12	Open	Closed	
		Battery voltage > value set in Program 13 or battery charging reaches floating stage	Closed	Open	

When program 38 is set to "enable" (only available for PLI 5000-48 and PLI 1000-12):

Inverter unit status	Condition		Dry contact port:	
			NC & C	NO & C
Power Off	Unit is off and no output is powered.		Closed	Open
Power On	Unit is in stand-by mode, line mode or fault mode.		Closed	Open
	Unit is in battery mode or power-saving mode.		Open	Closed



# Operation

## Power ON/OFF

Solarix PLI 5000-48

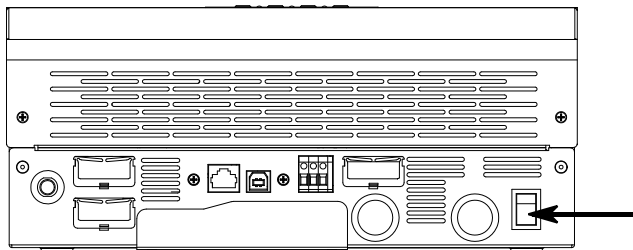

Solarix PLI 2400-24

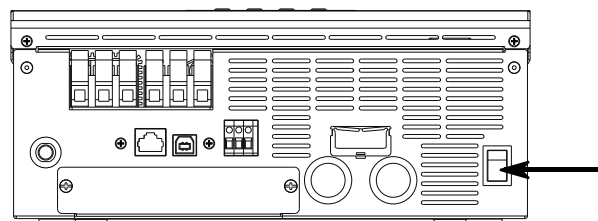

Figure 11: Power button

Once the unit has been correctly installed and the batteries are well connected, simply press the ON/OFF switch in *Figure 11* to the ON position (located on the button of the case) to turn on the inverter.

## Display and Control Panel

The operation and display panel, shown in *Figure 12*, is on the front panel of the inverter. It includes three LED indicator lamps, four function buttons and an LC-display, indicating the operating status.

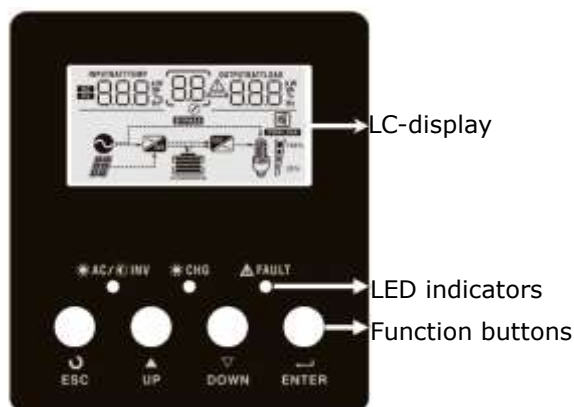

Figure 12: Display and control panel

### LED Indicators

LED Indicator		Meaning	
☀ AC / ⚡ INV	Green	Solid On	Output is powered by AC input in line mode
		Flashing	Output is powered by battery or PV in battery mode
☀ CHG	Green	Solid On	Battery is fully charged
		Flashing	Battery is charging
⚠ FAULT	Red	Solid On	Fault condition in the inverter
		Flashing	Warning condition in the inverter

**Function Buttons**

Button	Description
ESC	Exit setting mode
UP	Go to previous selection
DOWN	Go to next selection
ENTER	Confirm the selection in setting mode or enter setting mode

**LC-Display Icons**

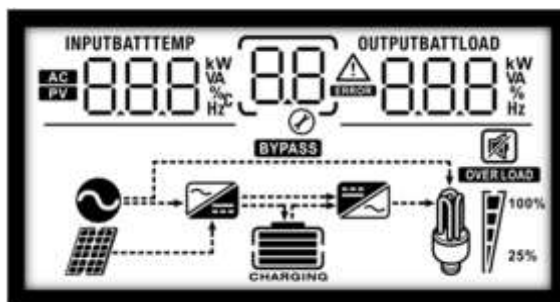

Figure 13: Display

Icon	Function description
<b>Input Source Information</b>	
	Indicates the AC input
	Indicates the PV input
	Indicates input voltage, input frequency, PV voltage, battery voltage or charger current
<b>Configuration Program and Fault Information</b>	
	Indicates the setting programs.
	Indicates the warning and fault codes. Warning:  flashing with warning code.
	Fault:  lighting with fault code
<b>AC Output Information</b>	
	Indicates output voltage, output frequency, load percent, load in VA, load in Watt and discharging current.

**Battery Information**









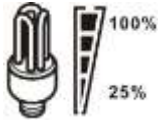

Indicates the approximate battery level as 0-24%, 25-49%, 50-74% and 75-100% bars in battery mode, or the charging status in line mode.

In AC / Line charging mode, it will present the battery charging status:

Status	Battery voltage	LC-Display
Bulk mode / Boost mode	< 2 V / cell	4 bars flash
	2 ~ 2.083 V / cell	Bottom is on, the other three bars flash
	2.083 ~ 2.167 V / cell	Bottom two bars on, the other two bars flash
	> 2.167 V / cell	Bottom three bars on, top bar flashes
Floating mode. Batteries are fully charged.		4 bars on

In battery mode it will present the approximate remaining battery capacity:

Inverter Load Level in %	Battery Voltage	LC-Display
Load > 50%	< 1.717 V / cell	
	1.717 V / cell ~ 1.8 V / cell	
	1.8 ~ 1.883 V / cell	
	> 1.883 V / cell	
50% > Load > 20%	< 1.817 V / cell	
	1.817 V / cell ~ 1.9 V / cell	
	1.9 ~ 1.983V / cell	
	> 1.983	
Load < 20%	< 1.867 V / cell	
	1.867 V / cell ~ 1.95 V / cell	
	1.95 ~ 2.033 V / cell	
	> 2.033	

Load Information (AC Output)				
	Indicates overload.			
	Indicates the load level as follows:			
	0%~24%	25%~49%	50%~74%	75%~100%
				
Operation Mode Information				
	Indicates the unit is connected to an AC source at the AC input terminal.			
	Indicates the unit is connected to PV modules.			
	Indicates the load is supplied by the AC input power source.			
	Indicates the AC charger circuit is in operation.			
	Indicates the DC to AC inverter circuit is in operation.			
Mute Operation				
	Indicates the unit's alarm is disabled.			











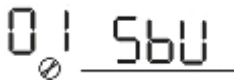

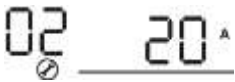
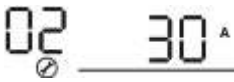



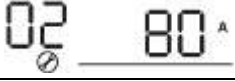
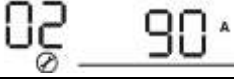
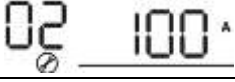
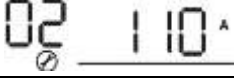
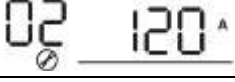
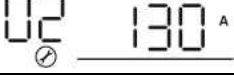

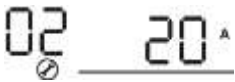
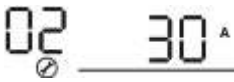

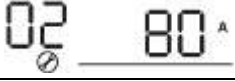
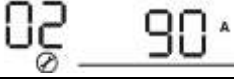
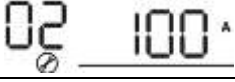
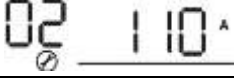
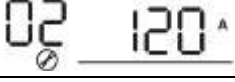
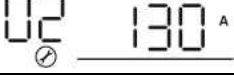

## Configuration

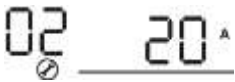
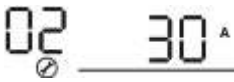
**CAUTION: Consult your battery manufacturer’s documentation to determine the optimal battery settings. KATEK Memmingen GmbH cannot be held responsible for incorrect battery settings or battery settings that are incompatible with the particular battery in use.**



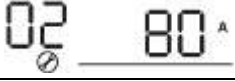
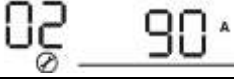
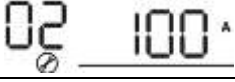
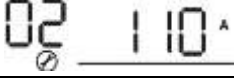
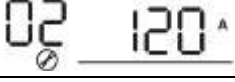
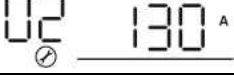



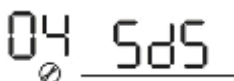

After pressing and holding the “ENTER” button for 3 seconds, the unit will enter its configuration / setting mode. Press the “UP” or “DOWN” button to select different setting programs. Then press the “ENTER” button to confirm the selection or “ESC” to exit.

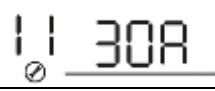
### Setting Programs:

Program	Description	Selectable option	
00	Exit setting mode	Escape 00 ESC	
01	Output source priority: To configure load power source priority	Solar first 01 SOL	<p>Solar energy provides power to the loads as first priority. If solar energy is not sufficient to power all connected loads, battery energy will supply power to the loads at the same time. The utility / AC input provides power to the loads only when any of these conditions happens:</p> <ul style="list-style-type: none"> <li>• Solar energy is not available.</li> <li>• Battery voltage drops to either low-level warning voltage or the setting in program 12.</li> </ul>
		AC in first (default) 01 UTI	<p>AC input / Utility will provide power to the loads as first priority. Solar and battery energy will provide power to the loads only when AC input power is not available.</p>



		SBU priority 	Solar energy provides power to the loads as first priority. If solar energy is not sufficient to power all connected loads, battery energy will supply power to the loads at the same time. Utility / AC input provides power to the loads only when battery voltage drops to either low-level warning voltage or the setting in program 12.														
02	Maximum charging current: configure the total charging current for solar and AC chargers combined.  <i>Max. charging current = AC charging current + solar charging current</i>  PLI 5000-48: max. 140 A PLI 2400-24: max. 120 A PLI 1000-12: max. 60 A	Available options: <table border="1"> <tr> <td>10 A </td> <td>20 A </td> </tr> <tr> <td>30 A </td> <td>40 A (default for PLI 1000-12) </td> </tr> <tr> <td>50 A </td> <td>60 A (default for PLI 2400-24) </td> </tr> <tr> <td>70 A </td> <td>80 A (default for PLI 5000-48) </td> </tr> <tr> <td>90 A </td> <td>100 A </td> </tr> <tr> <td>110 A </td> <td>120 A </td> </tr> <tr> <td>130 A </td> <td>140 A </td> </tr> </table>	10 A 	20 A 	30 A 	40 A (default for PLI 1000-12) 	50 A 	60 A (default for PLI 2400-24) 	70 A 	80 A (default for PLI 5000-48) 	90 A 	100 A 	110 A 	120 A 	130 A 	140 A 	
10 A 	20 A 																
30 A 	40 A (default for PLI 1000-12) 																
50 A 	60 A (default for PLI 2400-24) 																
70 A 	80 A (default for PLI 5000-48) 																
90 A 	100 A 																
110 A 	120 A 																
130 A 	140 A 																
03	AC input voltage range	Appliances 	Acceptable AC input voltage range within 90 – 280 V AC.														
		UPS (default) 	Acceptable AC input voltage range within 170 – 280 V AC.														
04	Power saving mode enable / disable	Disable (default) 	If disabled, the on/off status of inverter output will not be effected by the power of the load, the inverter will remain on.														





		Enable 04 SEN	If enabled, the output of inverter will turn off when the connected load is below ~ 50 W (20 W for PLI 1000-12). It will then test for a load every 5 seconds and turn back on above ~ 100 W (40 W for PLI 1000-12) load level.	
05	Battery type	AGM / Gel 05 AGn	Flooded / liquid electrolyte 05 FLd	
		User-Defined (default) 05 USE	If "User-Defined" is selected, the battery end-of-charge voltage and low battery cut-off voltage can be set in program 26, 27 and 29.	
06	Auto restart when overload occurs	Restart disable (default) 06 LtD	Restart enable 06 LfE	
	Regardless of this setting when the AC output is short-circuited, the inverter will shut-down and attempt to restart every 10 s. If it fails after 3 tries it will remain off. During the attempts, the AC output voltage never exceeds 20 VAC and is thus not dangerous to humans.			
07	Auto restart when over-temperature occurs	Restart disable 07 ttd	Restart enable (default) 07 tFE	
08	AC Output voltage (only available for PLI 2400-24)	220 VAC 08 220 <sup>v</sup>	230 VAC (default) 08 230 <sup>v</sup>	240 VAC 08 240 <sup>v</sup>
09	AC Output frequency	50 Hz (default) 09 50 <sub>Hz</sub>	60 Hz 09 60 <sub>Hz</sub>	
11	Maximum AC input charging current (only 10 A and 20 A available for PLI 1000-12)	Available options:		
		2 A 11 2A	10 A 11 10A	

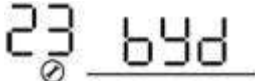
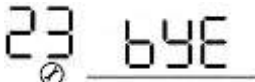





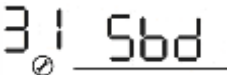

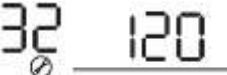
		20 A (PLI 1000-12 default) 	30 A (PLI 2400-24 / PLI 5000-48 default) 	
		40 A 	50 A 	
		60 A 		
12	Battery voltage below which the inverter immediately switches the power source to AC in / utility when selecting "SBU priority" or "Solar first" in program 01.	The default setting is 46 V and the range of settings is 44 V to 57 V in 1 V increments for each click for the PLI 5000- 48.  The default setting is 23.0 V and the range of settings is 22.0 V to 25.5 V in 0.5 V increments for each click for the PLI 2400-24.  The default setting is 12.5 V and the range of settings is 11.0 V to 12.8 V in 0.2 / 0.3 V increments for each click for the PLI 1000-12 (11.5 V default).	46 V (default for PLI 5000-48) 	23.0 V (default for PLI 2400-24) 
13	Battery voltage above which the inverter switches the power source back to solar / battery when selecting "SBU priority" or "Solar first" in program 01.	The default setting is 54 V and the range of settings is "FULL", as well as 48 V to 64 V in 1 V increments for each click for the PLI 5000-48.  The default setting is 27.0 V and the range of settings is "FULL", as well as 24.0 V to 29.0 V in 0.5 V increments for each click for the PLI 2400-24 (27.0 V default).  The default setting is 13.5 V and the range of settings is "FULL", as well as 12.0 V to 14.5 V in 0.2 / 0.3 V increments for each click for the PLI 1000-12 (13.5 V default).	Battery fully charged 	54 V (default for PLI 5000-48) 
16	Charger source priority  Notice:	If this inverter is not working in off-grid / battery or power- saving mode, the charger source can be programmed as below:		



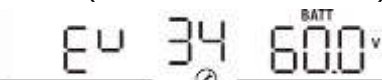

	If an AC utility is present and connected, it is recommended not to use the "Only Solar" setting for this program. Otherwise there would be a risk that, without any sunshine, the device will slowly discharge the battery with its own consumption. In this case it is recommended to use "Solar first" here and "2 A" (or higher) in program 11. This way the own consumption of the device, as well as the self-consumption of the battery can be covered with a generator in case there is no PV available at all.	Solar first 16 C50	Solar energy will charge battery as first priority. AC input / utility will charge battery only when solar energy is not available.
		Utility first 16 CUt	AC input / utility will charge battery as first priority. Solar energy will charge battery only when utility power is not available.
		Solar and Utility (default) 16 SNU	Solar energy and AC input / utility will charge battery at the same time.
		Only Solar 16 O50	Solar energy will be the only charger source no matter whether an AC source is available or not.
		If this inverter is working in off-grid / battery mode or power-saving mode, only solar energy can charge the battery. Solar energy will charge battery if it is available and sufficient.	
18	Alarm control (audible)	Alarm on (default) 18 bOn	Alarm off 18 bOf
19	Auto return to default display screen	Return to default display screen (default) 19 ESP	If selected, the display will always automatically return to the default display screen (input voltage / output voltage) after no button is pressed for 1 minute.
		Remain at last screen 19 LEP	If selected, the display screen will remain at the selected screen until the user finally switches to another screen / menu.
20	Backlight control	Backlight on (default) 20 LOn	Backlight off 20 LOF
22	Beeps while primary energy source is interrupted	Alarm on (default) 22 AOn	Alarm off 22 AOf

23	<p>Overload bypass: When enabled, the unit will transfer to AC input / line mode temporarily (min. 10 minutes) if an overload occurs in battery mode.</p>	<p>By-pass disable (default)</p> 	<p>By-pass enable</p> 
26	<p>Boost charging voltage (absorption charging stage, see <i>Figure 12</i>)</p>	<p>If "User-defined" is selected in program 05, this program can be configured.</p> <p>The range of settings is from 48.0 V to 64.0 V in 0.1 V increments for each click for the PLI 5000-48.</p> <p>The range of settings is from 24.0 V to 29.2 V in 0.1 V increments for each click for the PLI 2400-24 (28.8 V default).</p> <p>The range of settings is from 12.0 V to 14.6 V in 0.1 V increments for each click for the PLI 1000-12 (14.4 V default).</p> <p>57.6 V (default for PLI 5000-48)</p> 	
27	<p>Float voltage (see <i>Figure 12</i>)</p>	<p>If "User-defined" is selected in program 05, this program can be configured.</p> <p>The range of settings is from 48.0 V to 64.0 V in 0.1 V increments for each click for the PLI 5000-48.</p> <p>The range of settings is from 24.0 V to 29.2 V in 0.1 V increments for each click for the PLI 2400-24 (28.2 V default).</p> <p>The range of settings is from 12.0 V to 14.6 V in 0.1 V increments for each click for the PLI 1000-12 (14.1 V default).</p> <p>56.4 V (default for PLI 5000-48)</p> 	

<p>29</p>	<p>Low DC / battery cut-off voltage</p>	<p>If "User-defined" is selected in program 05, this program can be configured. If the battery voltage drops below this level for more than 3 seconds, the inverter switches off to protect the battery, regardless of the AC load power.</p> <p>The range of settings is from 40.0 V to 54.0 V in 0.1 V increments for each click for the PLI 5000-48.</p> <p>The range of settings is from 20.0 V to 24.0 V in 0.1 V increments for each click for the PLI 2400-24 (21.0 V default).</p> <p>The range of settings is from 10.0 V to 12.0 V in 0.1 V increments for each click for the PLI 1000-12 (10.5 V default).</p>	
<p>42.0 V (default for PLI 5000-48)</p>			
<p>31</p>	<p>Solar power balance: When enabled, solar input power will be automatically adjusted according to connected load power.</p> <p>Not available for PLI 1000-12.</p>	<p>Solar power balance enable (default):</p> 	<p>If selected, solar input power will be automatically adjusted according to the following formula: <i>Max. input solar power = Max. battery charging power + connected load power</i></p>
<p>Solar power balance disable:</p> 		<p>If selected, the solar input power will be the same as the max. battery charging power no matter how much power the connected loads require. The max. battery charging power will be based on the current setting in program 02: <i>Max. input solar power = Max. battery charging power</i></p>	
<p>32</p>	<p>Boost charging time (absorption charging stage, see Figure 12) Not available for PLI 1000-12.</p>	<p>If "User-Defined" is selected in program 05, this program can be configured.</p> <p>The setting range is "Automatic" and from 5 min. to 900 min. The increment of each click is 5 min.</p>	
<p>Automatic</p> 		<p>If selected, the device will set this automatically, as described in "Charge Mode Specifications"</p>	
<p>120 minutes (default)</p> 			



33	Battery equalisation (see chapter " <b>Battery Equalisation</b> ")	If "Flooded" or "User-Defined" is selected in program 05, this program can be configured.	
		Battery equalisation enable 	Battery equalisation disable (default) 
34	Battery equalisation voltage (see Figure 12)	The range of settings is from 48.0 V to 64.0 V in 0.1 V increments for each click for the PLI 5000-48.	
		The range of settings is from 24.0 V to 29.2 V in 0.1 V increments for each click for the PLI 2400-24 (29.2 V default).	
		The range of settings is from 12.0 V to 14.6 V in 0.1 V increments for each click for the PLI 1000-12 (14.6 V default).	
		60.0 V (default for PLI 5000-48) 	
35	Battery equalisation duration (see Figure 12)	60 min (default) 	The setting range is from 5 min to 900 min. The increment of each click is 5 min.
36	Battery equalisation timeout (see Figure 13)	120 min (default) 	The setting range is from 5 min to 900 min. The increment of each click is 5 min.
37	Battery equalisation interval (see chapter " <b>Battery Equalisation</b> ")	30 days (default) 	The setting range is from 0 to 90 days. The increment of each click is 1 day.
38	Allow neutral and protective earth of AC output to be connected together: When enabled, inverter can deliver a signal to trigger an additional external grounding box to short neutral (N) and protective earth (PE), see chapter " <b>Dry Contact Signal</b> " for details. Only available for PLI 5000-48 and PLI 1000-12.	This function is only usable when the inverter is connected to an external grounding box. When the inverter is working in battery mode (AC input is disconnected), it will trigger the dry contact and thus the grounding box to connect neutral and protective earth of the AC output together.	
		Disable: dry contact is for triggering external power sources like gensets (default) 	
		Enable: signal to external grounding box for connecting neutral and protective earth on AC output in battery mode 	

39	Battery equalisation activated / forced immediately	<p>If the equalisation function is enabled in program 33, this program can be configured. If "Enable" is selected in this program, battery equalisation will commence immediately and LCD main page will shows "E9". If "Disable" is selected, it will cancel the equalisation function until next activated by the equalization interval defined in program 37 setting. During scheduled equalisation "E9" will not be shown in the LCD default view.</p>	
		<p>Enable</p> 	<p>Disable (default)</p> 



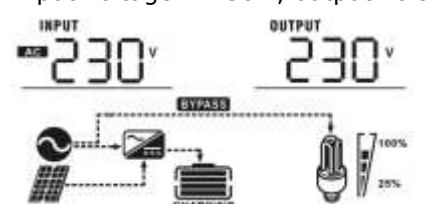

Any setting programs not explicitly mentioned in this chapter are irrelevant when using a single unit and should not be changed!

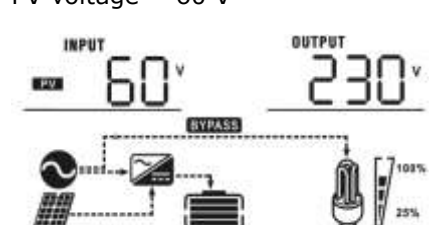
## Display Setting

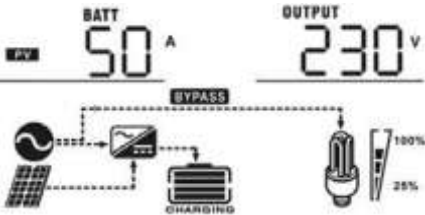
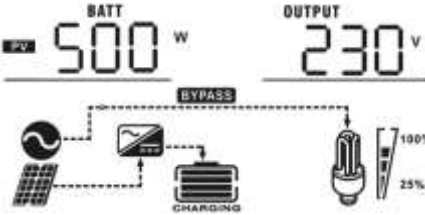
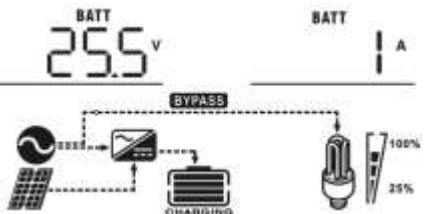
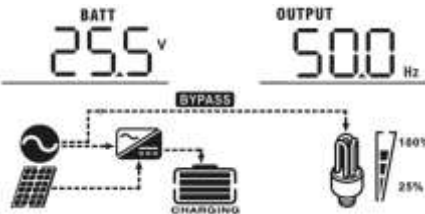
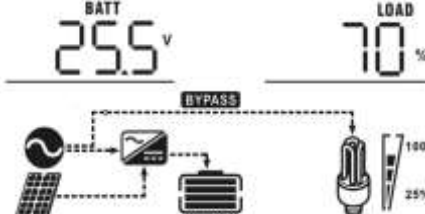

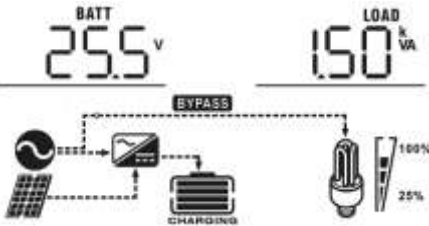

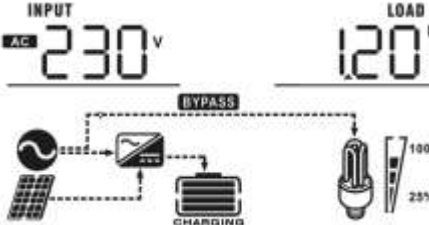
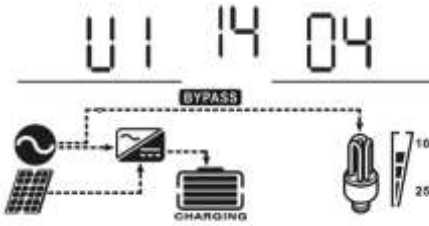

The LCD display information can be cycled by pressing the "UP" or "DOWN" button. The selectable information is cycled in this order: input voltage, input frequency, PV voltage, charging current, charging power, battery voltage, output voltage, output frequency, load percentage, load in VA, load in Watt, DC discharging current, main CPU version and second CPU version. The values shown are examples only and not necessarily valid for all inverter models.

Selectable information	LC-display
AC input voltage / AC output voltage (default display view)	<p>Input voltage = 230 V, output voltage = 230 V</p> 
AC Input frequency	<p>Input frequency = 50 Hz</p> 
PV voltage	<p>PV voltage = 60 V</p> 

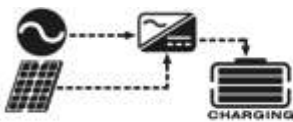
<p>PV charging current</p>	<p>PV charging current = 50 A</p> 
<p>PC charging power</p>	<p>PV Charging power = 500 W</p> 
<p>Battery voltage / DC discharging current</p>	<p>Battery voltage = 25.5 V, discharging current = 1 A</p> 
<p>Output frequency</p>	<p>Output frequency = 50 Hz</p> 
<p>Load percentage of nominal inverter power</p>	<p>Load percent = 70%</p> 

<p>Load in VA</p>	<p>When the connected load power &lt; 1 kVA, it is shown as VA:</p>  <p>When the load power ≥ 1 kVA, it is shown as kVA:</p> 
<p>Load in Watt</p>	<p>When the connected load power &lt; 1 kW, it is shown as W:</p>  <p>When the load power ≥ 1 kW, it is shown as kW:</p> 
<p>Main CPU version</p>	<p>Main CPU version 00014.04:</p> 
<p>Secondary CPU version</p>	<p>Secondary CPU version 00003.03:</p> 

## Operating Mode Description

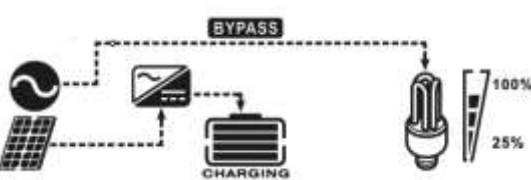
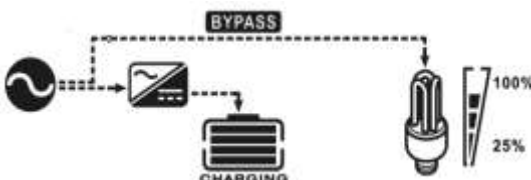
Operation mode	Description	LC-display
<p>Stand-by mode / power saving mode</p> <p>Note:</p> <ul style="list-style-type: none"> <li>Stand-by mode: The inverter is not powered on yet but at this time, the inverter can charge the battery without AC output.</li> <li>Power saving mode: If enabled, the AC output of the inverter will be turned off when the connected load is below ~ 50 W and turn back on when the load is above ~ 100 W.</li> </ul>	<p>No AC output is supplied by the unit but it can charge batteries.</p>	<p>Charging by AC input and PV energy.</p> 
		<p>Charging by AC input.</p> 
		<p>Charging by PV energy.</p> 
		<p>No charging.</p> 
<p>Fault mode</p> <p>Note:</p> <ul style="list-style-type: none"> <li>Errors are caused by internal circuit errors or external causes such as over-temperature, a short-circuited output etc.</li> </ul>	<p>PV energy can charge batteries, depending on the type of fault.</p>	<p>Charging by PV energy.</p> 
		<p>No charging.</p> 
<p>Line mode</p>	<p>The unit will provide power from the AC input directly to the AC output. It can also charge the battery in line mode.</p>	<p>Charging by PV energy.</p> 
		<p>Charging from AC input.</p> 



Battery mode	The unit will provide AC output power from the battery and PV power. Simultaneous charging from the AC input is not possible.	Power from battery and PV energy.
		Power from battery only.

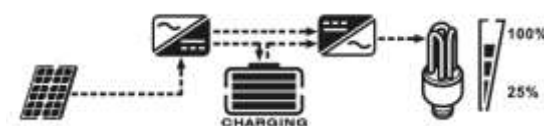

## Recommendation for generator as AC input source

Since the generator not only supplies the loads at the AC output but also recharges the battery, it is generally recommended to use a generator with at least twice the size of the inverter.

Further technical requirements of the generator:

- Generator waveform THD: < 30%.
- If the generator outputs a square wave, output duty should greater than 60%
- Generator Vrms range: 100 ~ 270VAC
- Generator voltage crest factor ( $V_{peak}/V_{rms}$ ): < 1.6
- Generator peak voltage: <380V
- Generator frequency range: 45Hz ~ 63Hz
- Generator frequency slew rate: < 0.3Hz/sec











## Internal Fan

As the power density of the Solarix PLI is very high, the fans are always running at low speed to keep the air moving at about  $\frac{1}{4}$  speed. The fans are PWM controlled and operate proportionally to the inverter / PV power. This is to cool the power components before heat-buildup occurs in the first place.









If the environment is sensitive to noise we advise to install in a closed room with sufficient cooling.

## Fault Reference Code

Fault Code	Fault Event	Display symbol shown
01	Fan is locked when inverter is off	
02	Over temperature	
03	Battery voltage is too high	
04	Battery voltage is too low	
05	Output short-circuited / over-loaded or over-temperature is detected by internal inverter components	
06	Output voltage is abnormal	
07	Overload time-out / duration too long	

08	Internal bus voltage is too high	
09	Battery soft-start failed	
11	Main relay failed	
51	Over-current or surge	
52	Internal bus voltage is too low	
53	Inverter soft-start failed	
55	DC voltage detected on AC output	
56	Battery disconnected	
57	Current sensor failed	
58	AC output voltage is too low	

## Warning Reference Code

Warning Code	Warning Event	Audible Alarm	Icon flashing
01	Fan is locked when inverter is on	Beeps three times every second	
03	Battery is over-charged	Beeps once every second	
04	Low battery voltage	Beeps once every second	
07	Overload	Beeps once every 1/2 second	
10	Output power derating	Beeps twice every 3 seconds	
12	Solar charger stopped due to low battery voltage		
13	Solar charger stopped due to high PV voltage		
14	Solar charger stopped due to overload		
E9	Forced battery equalisation active		

## Battery Equalisation

The charge controller is equipped with an equalisation function. It reverses the buildup of negative chemical effects like stratification, a condition where acid concentration is greater at the bottom of the battery than at the top. Equalization also helps to remove sulfate crystals that might have built up on the plates. If left unchecked, this condition, called sulfation, will gradually reduce the overall capacity of the battery. Therefore, it is recommended to equalise battery periodically if it is a flooded / liquid-electrolyte type lead-acid battery. Refer to your battery manual or manufacturer for compatibility.

### How to Apply the Equalisation Function

The function can be enabled in program 33, chapter "Configuration". Once the equalisation function is enabled it can be configured with the following parameters:

1. "Equalisation voltage" in program 34, chapter "Configuration". This defines the desired battery voltage during the equalisation phase.
2. "Equalisation duration" in program 35, chapter "Configuration". This defines the duration of the equalisation program in minutes.
3. "Equalisation timeout" in program 36, chapter "Configuration". This defines the maximum duration of the equalisation program in minutes. The duration may be prolonged due do voltage fluctuations at the battery or insufficient power from the charger. This timeout ensures that the equalisation process is stopped, at the latest after the timeout has elapsed.
4. "Equalisation interval" in program 37, chapter "Configuration". Once the equalisation is completed this interval defines when the charger automatically proceeds with the next equalisation cycle.
5. "Battery equalisation activated / forced immediately" in program 39, chapter "Configuration".

### When Equalisation takes place

In the float charging stage, once the equalisation interval is reached, or equalisation is forced immediately with program 39 in the chapter "Configuration", the charge controller will start to enter the equalisation phase (see Figure 12).

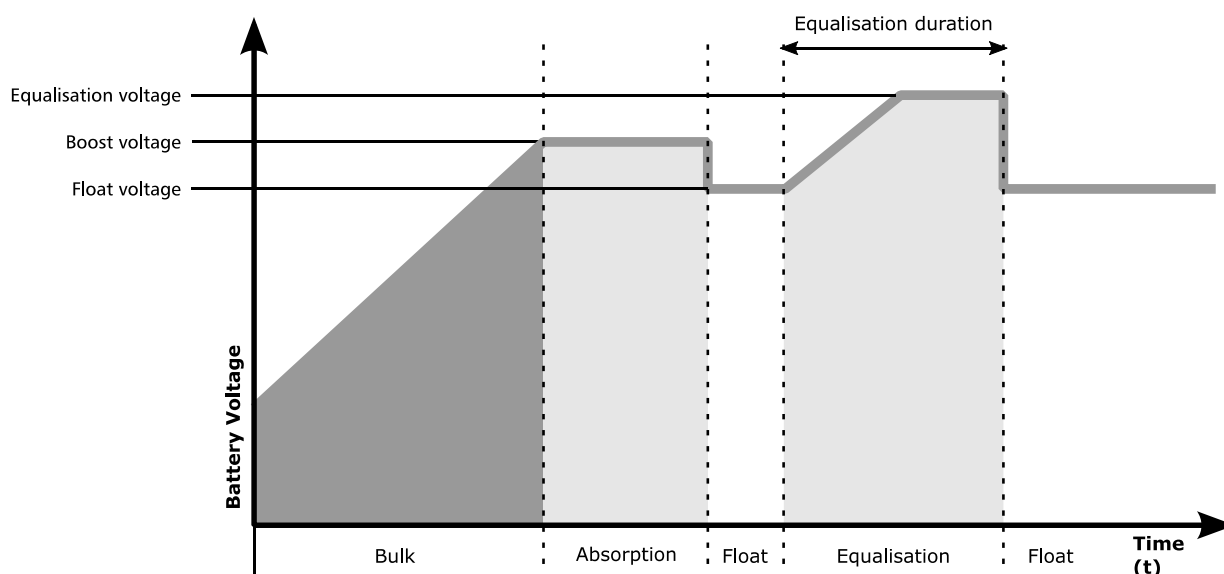

Figure 14: Charging curve

### Equalisation duration and timeout

In the equalisation phase, the charge controller will supply power to charge the battery as much as possible until the battery voltage raises to battery equalisation voltage defined in program 34 in the chapter “**Configuration**”. Then, constant-voltage regulation is applied to maintain the battery voltage at the battery equalisation voltage level. The battery will remain in the equalisation phase until the equalisation duration in program 35 in the chapter “**Configuration**” has elapsed (see *Figure 12*).

However, during the equalisation phase, once the equalisation duration has elapsed and if the battery voltage has not reached the equalisation voltage, the charge controller will extend the battery equalisation phase time until the battery voltage reaches the equalisation voltage. If battery voltage is still lower than the equalisation voltage once the equalisation timeout has elapsed, the charge controller will exit the equalisation phase and return to float phase (see *Figure 13*).

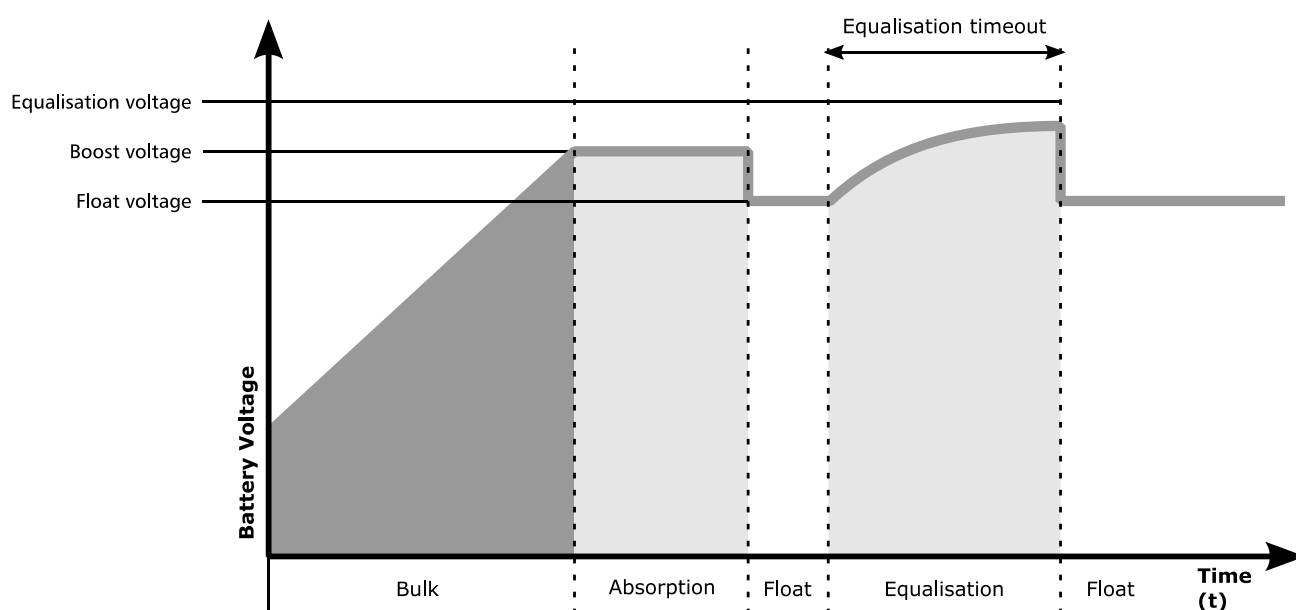

Figure 15: Equalisation timeout

## Specifications

### Line Mode Specifications

Inverter model	Solarix PLI 5000-48	Solarix PLI 2400-24	Solarix PLI 1000-12
Input Voltage Waveform	AC sinusoidal (utility or generator)		
Nominal AC Input Voltage *	230 VAC		
Min. Input Voltage Cut-Off	170 VAC $\pm$ 7 V (UPS mode) 90 VAC $\pm$ 7 V (Appliances mode)		
Min. Input Voltage Return	180 VAC $\pm$ 7 V (UPS mode) 100 VAC $\pm$ 7 V (Appliances mode)		
Max. Input Voltage Cut-Off	280 VAC $\pm$ 7 V		
Max. Input Voltage Return	270 VAC $\pm$ 7 V		
Absolute Max. AC Input Voltage	300 VAC		
Nominal Input Frequency *	50 Hz / 60 Hz (Auto detection)		
Min. Input Frequency Cut-Off	40 Hz $\pm$ 1 Hz		

Min. Input Frequency Return	42 Hz $\pm$ 1 Hz		
Max. Input Frequency Cut-Off	65 Hz $\pm$ 1 Hz		
Max. Input Frequency Return	63 Hz $\pm$ 1 Hz		
AC Output Short-Circuit Protection	Line mode: Circuit Breaker rated at 40 A Battery mode: Electronic Protection (see program 06 in chapter „ <b>Configuration</b> “)	Line mode: Circuit Breaker rated at 30 A Battery mode: Electronic Protection (see program 06 in chapter „ <b>Configuration</b> “)	Line mode: Circuit Breaker rated at 10 A Battery mode: Electronic Protection (see program 06 in chapter „ <b>Configuration</b> “)
Efficiency between AC input and AC output (Line Mode)	> 99%		
Transfer Time between line mode and battery mode *	10 ms typical (UPS mode) 20 ms typical (Appliances mode)		
Output power de-rating:	In Line Mode the maximum load current is always 40 A. Therefore the available maximum power depends on the actual AC input voltage. For example at an input voltage of 230 VAC x 40 A = 9.2 kW. And an input voltage of 170 VAC x 40 A = 6.8 kW.	In Line Mode the maximum load current is always 30 A. Therefore the available maximum power depends on the actual AC input voltage. For example at an input voltage of 230 VAC x 30 A = 6.9 kW. And an input voltage of 170 VAC x 30 A = 5.1 kW.	In Line Mode the maximum load current is always 10 A. Therefore the available maximum power depends on the actual AC input voltage. For example at an input voltage of 230 VAC x 10 A = 2.3 kW. And an input voltage of 170 VAC x 10 A = 1.7 kW.

\* As soon as a valid voltage and frequency is detected at the AC input, the inverter will synchronise its AC output frequency to the input in battery mode. This is to avoid a frequency mismatch between the AC input and AC output and to enable the fast switching times typical of uninterruptible power supplies (UPS).

## Inverter / Battery Mode Specifications

Inverter model	Solarix PLI 5000-48	Solarix PLI 2400-24	Solarix PLI 1000-12
Rated Output Power	5000 W / 5000 VA	2400 W / 3000 VA	1000 W / 1200 VA
Output Voltage Waveform	Pure sine wave		
Output Voltage Regulation	230 VAC $\pm$ 5%	220, 230 or 240 VAC $\pm$ 5% (selectable)	230 VAC $\pm$ 5%
Output Frequency	50 Hz or 60 Hz (selectable)		

Efficiency (DC to AC)	> 93% peak efficiency, > 91% efficiency between 20% and 100% of nominal output power at 48 VDC battery voltage	> 91% peak efficiency, > 90% efficiency between 30% and 100% of nominal output power at 24 VDC battery voltage	90% peak efficiency, > 88% efficiency between 30% and 85% of nominal output power at 12 VDC battery voltage
Overload Protection / Disconnect	5 seconds at $\geq 150\%$ load; 10 seconds at $110\% \sim 150\%$ load		
Surge Capacity	2 x rated power for 5 seconds		
Nominal Battery Input Voltage	48 VDC	24 VDC	12 VDC
Minimum battery voltage for power up of inverter	46.0 VDC	23.0 VDC	11.5 VDC
Low Battery Warning Voltage at load < 20% at $20\% \leq$ load < 50% at load $\geq 50\%$	44.0 VDC 42.8 VDC 40.4 VDC	22.0 VDC 21.4 VDC 21.4 VDC	11.0 VDC 10.7 VDC 10.1 VDC
Low Bat. Warning Return Voltage at load < 20% at $20\% \leq$ load < 50% at load $\geq 50\%$	46.0 VDC 44.8 VDC 42.4 VDC	23.0 VDC 22.4 VDC 21.2 VDC	11.5 VDC 11.2 VDC 10.6 VDC
Low Battery Cut-off Voltage (only valid for "AGM / Gel" or "Flooded" battery types in Program 05) at load < 20% at $20\% \leq$ load < 50% at load $\geq 50\%$	42.0 VDC 40.8 VDC 38.4 VDC	21.0 VDC 20.4 VDC 20.4 VDC	10.5 VDC 10.2 VDC 9.6 VDC
High Battery Cut-off Voltage	66 VDC	30 VDC	15.5 VDC
High Battery Recovery Voltage	62 VDC	29 VDC	14.5 VDC
No Load Power Consumption	< 50 W	< 45 W	< 17 W
Saving Mode Power Consumption	< 15 W	< 14 W	< 4 W

## Charge Mode Specifications

Utility / AC and PV Charging Modes				
Inverter model		Solarix PLI 5000-48	Solarix PLI 2400-24	Solarix PLI 1000-12
Maximum Charging Current from AC Source		60 ADC		20 ADC
Boost Charging Voltage	Flooded Battery	58.4 VDC	29.2 VDC	14.6 VDC
	AGM / Gel Battery	56.4 VDC	28.2 VDC	14.1 VDC

Floating Charging Voltage (Flooded or AGM / Gel Battery setting)	54 VDC	27 VDC	13.5 VDC
Overcharge Protection	66 VDC	30 VDC	15.5
Charging Algorithm	3-Step + Equalisation (optional, see chapter " <b>Battery Equalisation</b> ")		
Charging Curve (valid for AC charging and PV charging):  $T1 = 10 \times T0$ $10 \text{ minutes} \leq T1 \leq 8 \text{ hours}$  for "Automatic" in program 32, else T1 is the fixed value defined in program 32.			

<b>Solar / PV Charging Mode</b>			
<b>Inverter model</b>	<b>Solarix PLI 5000-48</b>	<b>Solarix PLI 2400-24</b>	<b>Solarix PLI 1000-12</b>
Rated Power	4800 W	1168 W	550 W
Efficiency	98% max.; $\geq 96\%$ between 1 kW and 4 kW PV power at $\sim 90$ Vmpp PV voltage	98% max.; $\geq 95\%$ between 100 W and 900 W PV power at $\sim 60$ Vmpp PV voltage	95% max.; $\geq 85\%$ between 100 W and 550 W PV power at $\sim 60$ Vmpp PV voltage
Max. PV Array Open Circuit Voltage	145 VDC	100 VDC	100 VDC
PV Array MPPT Voltage Range	Minimum 60 VDC, recommendation 68 $\sim$ 115 VDC	Minimum 30 VDC, recommendation 34 $\sim$ 80 VDC	Minimum 15 VDC recommendation 17 $\sim$ 80 VDC
Min. battery voltage for PV charging	34 VDC	17 VDC	8.5 VDC
Standby Power Consumption	2 W		
Battery Voltage Measurement Accuracy	$\pm 0.3\%$		
PV Voltage Measurement Accuracy	$\pm 2$ V		

<b>Simultaneous Utility / AC and Solar / PV Charging</b>			
Maximum Charging Current	140 A	100 A	60 A
Default Charging Current	80 A	60 A	40 A

## General Specifications

Inverter model	Solarix PLI 5000-48	Solarix PLI 2400- 24	Solarix PLI 1000- 12
Safety & EMC Certification	CE, for further details visit <a href="http://www.steca.com">www.steca.com</a>		
Operating Temperature Range	0 °C to 55 °C, derating from 40 °C		
Storage Temperature	-15 °C ~ 60 °C		
Degree of Protection	IP 21		
Humidity	5 % to 90 % relative humidity (non-condensing)		
Operating Altitude	1000 m a.s.l., 1% nominal power derating per 100 m over 1000 m		
AC Terminal (fine / single wire)	6 mm <sup>2</sup> / AWG 8		
PV Terminal (fine / single wire)	10 mm <sup>2</sup> / AWG 6	6 mm <sup>2</sup> / AWG 8	
Battery connection (fine wire)	35 mm <sup>2</sup> ... 50 mm <sup>2</sup> / AWG 2 ... AWG 0	25 mm <sup>2</sup> / AWG 3	
Dimension (width x height x depth)	298 x 469 x 130 mm	275 x 385 x 114 mm	243 x 331 x 115
Net Weight	11.5 kg	7.6 kg	6.9 kg

## Troubleshooting

### Shutdown procedure

When a fault is detected, the inverter will often times shut down automatically to prevent further complications. This is followed by a restart of the unit. If you encounter a fault which requires a manual or emergency shutdown please adhere to the following steps:

- Shut down the inverter unit using the power button
- If available switch off attached fuses in the PV input, AC input and battery connections
- Contact your local retailer for support. They will help you with any issues you may have.

Solarix PLI 5000-48

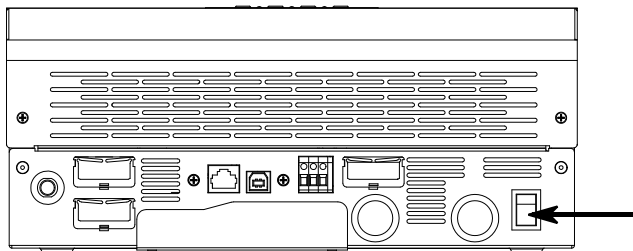

Solarix PLI 2400-24

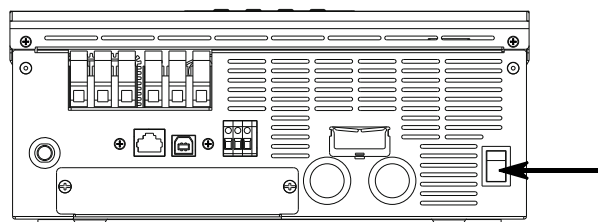

Figure 16: Power button

**CAUTION: The unit is not fully shut down until the PV input, AC input and battery connections are properly separated and disconnected.**



## Maintenance

Except for the care of its exterior the inverter does not require maintenance.

- Remove dust with compressed air (max. 2 bar)
- Remove soiling with a dry cloth. Using a damp or even wet cloth can damage the inverter.

	<p><b>WARNING: Shock Hazard. Maintenance must be performed with care due to high battery voltage in series.</b></p> <p><b>Shut down the inverter before any cleaning procedures.</b></p> <p><b>Only use a dry cloth to clean the outsides of the inverter.</b></p> <p><b>Do not clean the insides of the inverter.</b></p> <p><b>Any repair work may only be carried out by the manufacturer's customer service department</b></p>
---	--

## Troubleshooting

Problem	LCD / LED / Buzzer	Explanation / Possible cause	What to do
Unit shuts down automatically during start-up process.	LCD/LEDs and buzzer will be active for 3 seconds and then complete shut-off.	The battery voltage is too low (< 1.91 V / Cell)	<ol style="list-style-type: none"> <li>1. Re-charge battery.</li> <li>2. Replace battery.</li> </ol>
No response after power on.	No indication.	<ol style="list-style-type: none"> <li>1. The battery voltage is far too low (&lt; 1.4 V / Cell)</li> <li>2. Battery polarity reversed</li> </ol>	<ol style="list-style-type: none"> <li>1. Check if batteries and the wiring are correctly connected.</li> <li>2. Re-charge battery.</li> <li>3. Replace battery.</li> </ol>
AC input is active but the unit only works in battery mode.	Input voltage is displayed as 0 on the LCD and green LED is flashing.	Input protector is tripped	Check if AC breaker is tripped and AC wiring is correctly connected.
	Green LED is flashing.	Insufficient quality of AC power (mains power or generator)	<ol style="list-style-type: none"> <li>1. Check if AC wires are too thin and/or too long.</li> <li>2. Check whether generator (if applied) is working well or if input voltage range setting is correct (switch from "UPS" to "Appliances" in settings program 03).</li> </ol>
	Green LED is flashing.	"Solar First" set as prio. of output source	Change the output source priority to "Utility first".

When the unit is turned on, the internal relay is switched on and off repeatedly.	LCD display and LEDs are flashing.	Battery is disconnected	Check if battery fuse & wires are correctly connected.
Buzzer beeps continuously and red LED is on.	Fault code 07	Overload error. The inverter is overloaded to $\geq$ its nominal power and the overload-time-out has elapsed.	Reduce the connected load by switching off some loads.
	Fault code 05	Output short circuited	Check if wiring is correctly connected and remove abnormal load.
	Fault code 03	Battery is over-charged	Check if there are any external chargers directly connected to the battery. If not, contact your dealer.
		The battery voltage is too high	Check if the specification and quantity of batteries meet the necessary requirements.
	Fault code 02	Internal temperature of inverter components is over 100 °C	Check whether the air flow of the unit is blocked or whether the ambient temperature is too high.
	Fault code 01	Fan fault	Contact your dealer.
	Fault code 06/58	AC Output abnormal (inverter voltage < 190 VAC or > 260 VAC)	1. Reduce the connected load. 2. Contact your dealer.
	Fault code 08/09/53/57	Internal components failed	Contact your dealer.
	Fault code 51	Over-current or surge	Restart the unit, if the error happens again, please contact your dealer.
	Fault code 52	DC Bus voltage is too low	
Fault code 55	Output voltage is unbalanced		
Fault code 56	Battery is not connected correctly or battery fuse is burnt	If the battery is connected correctly, please contact your dealer.	

---

## Guarantee Conditions

Conditions are available on the Internet at:

[https://www.steca.com/index.php?5\\_Jahre\\_Garantie5ea97a3a7b893](https://www.steca.com/index.php?5_Jahre_Garantie5ea97a3a7b893)

## Exclusion of Liability

The manufacturer can neither monitor the compliance with this manual nor the conditions and methods during the installation, operation, usage and maintenance of the controller. Improper installation of the system may result in damage to property and, as a result, to bodily injury.

Therefore, the manufacturer assumes no responsibility and liability for loss, damage or costs which result from or are in any way related to incorrect installation, improper operation, incorrect execution of installation work and incorrect usage and maintenance.

Similarly, we assume no responsibility for patent right or other right infringements of third parties caused by usage of this controller. The manufacturer reserves the right to make changes to the product, technical data or installation and operating instructions without prior notice.

## Contact

In the case of complaints or faults, please contact the local dealer from whom you purchased the product. They will help you with any issues you may have.

KATEK Memmingen GmbH  
Mammostrasse 1  
87700 Memmingen  
Germany

E-mail [service@stecasolar.com](mailto:service@stecasolar.com)  
Internet [www.steca.com](http://www.steca.com)