

VLRV Elite Series Battery System

User Manual

V2.3

Content

1 Overview	1
1.1 Application Scope	1
1.2 Applicable People	1
1.3 User Manuel	1
1.4 Disclaimers	1
2 Product description	2
3 Safety Instructions	3
3.1 Label Description.....	3
3.2 Installation Tools.....	4
3.3 Attention Items.....	4
4 Product Description	5
4.1 Product Introduction	5
4.2 Battery Diagram.....	5
4.2.1 VLRV1280A Appearance & Dimension Schematic.....	6
4.2.2 VLRV2560(A/B) Appearance & Dimension Schematic.....	6
4.2.3 VLRV5120(A/B/C) Appearance & Dimension Schematic.....	8
4.3 VRLA Series Battery Front Panel Diagram.....	8
4.4 VRLV2560,5120 batter LED Indicator status and definition.....	9
4.5 VRLV 2560, 5120 battery communication Port Diagram and Description.....	9
5 Battery Installation	10
5.1 Handling, Transportation, Storage	10
5.1.1 Handling.....	10
5.1.2 Transportation.....	10
5.1.3 Storage.....	10
5.2 Battery Installation Requirement.....	11
5.2.1 Environment Requirement.....	11
5.2.2 Open-box Inspection.....	11
5.2.3 Precautions before installation.....	12
5.3 Battery Installation.....	12
5.3.1 VRLV1280A battery Installation and Wiring.....	12
5.3.2 VRLV 2560(A/B), 5120(A/B/C) battery Installation and Wiring.....	13
6 Battery Use	16
6.1 battery charging	16
6.1.1 Charge Protecting Mode - Intelligent VoltGo BMS protection function.....	16
6.2 Bluetooth Setting.....	19
6.2.1 Use as a lead acid battery.....	17
6.2.2 When battery needs to communicate with the inverter.....	18
6.3 Supplementary Power.....	20
6.4 Battery Discharge and End-of-life Judgment.....	20
6.4.1 Battery Discharge.....	20
6.4.2.....	20

7 Maintenance.....	21
7.1 Clean.....	21
7.2 Common Faults (Phenomenon) and Solutions	21
7.3 Daily Maintenance.....	20
8 Cautions.....	23
8.1 Cautions.....	23
8.2 Description of Warranty.....	23

Revision Table

No	Version	Revised by	Content	Revision Date
1	Rev1.0		First release	2022.09.06
2	Rev2.0		Update	2023.07.24
3	Rev2.1		Update	2023.08.02
4	Rev2.2		Update	2024.03.05
5	Rev2.3		Update	2024.04.11

1 Overview

1.1 Application Scope

This manual introduces the information about Voltgo Elite series Lithium iron phosphate battery (LFP) products, including product specifications, operation specifications, product maintenance and other related information.

These LFP battery products are developed by Voltgo power, have been widely used in many scenarios, such as solar light, toy car, medical cart, RV, E-boat etc. The Elite series battery is divided into three categories:

VRLV1280(A), VRVL2560(A/B), and VRLV5120(A/B/C), totaling six products.

1.2 Applicable People

This manual is used for professional and technical staff who installs, operates and maintains the batteries, as well as for the user who may need to view the relevant technical parameters. Anyone who operates must be qualified for electrical work.

1.3 User Manual

Before you operate the battery module, you should be better trained and read the manual carefully, to ensure that the person using the product is fully understood. Remove any possible metallic shorting risk of Jewel, Watches, and Pens. Metal bars and frames. After reading, please keep it in a safe place for future reference.

1.4 Disclaimers

It may cause serious injury to yourself or others, or result in damage to the product or property, if fail to operate this product properly. Once using, you will be deemed to have understood, acknowledged and accepted all the terms and contents in this document. Users undertake to be responsible for their own actions and all the consequences arising there from. The company shall not be liable for all damages caused by the user's failure in accordance with the provisions of this document and the user manual.

The content of this manual will be constantly updated and revised, and update, revision or termination without prior notice. So please visit the official website or obtain the latest product manual through your local distributors.

2 Product description

Lithium iron phosphate batteries are a new generation of green energy batteries. In recent years, with the rapid development of lithium ion battery technology, the pace of lithium ion batteries to replace the traditional lead-acid batteries is also gradually accelerated in various power fields.

Voltgo power develops and produces LFP battery products, which are suitable for low-voltage lead-acid replacement applications. These products adopt the highest safety performance lithium iron phosphate cells, with a high-precision battery management system (BMS), which can monitor and collect voltage, current and temperature of cells in the module in real time. The BMS also has a passive balance function, advanced battery control strategy, which can improve the performance of the battery pack further.

Elite series battery products consists of LFP battery module, BMS/BMU, housing and wire. Each module owns complete protection function. The modules can be connected in parallel to meet the expansion needs.











Elite series battery products are designed with ABS shell, can be used 24/7, which has outstanding advantages such as waterproof, impact resistance, good insulation performance, easy installation and maintenance-free. Some products also have special functions such as Bluetooth and low-temperature heating, which can meet the application needs of RVs, solar street lights, small medical equipment, toys and some small energy storage application.

3 Safety Instructions

3.1 Label Description









In order to ensure the user's personal safety when using this product, this manual provides relevant identification information and uses appropriate symbols to alert the user, who should carefully read the following list of symbols used in this manual.

Table 3-1 Label description

	Potentially low risk: may result in mild or moderate impairment if not avoided
	High Risk: May result in serious injury or death if not avoided
	The battery terminals must be disconnected before commencing on the battery
	The battery could explode and/or be severely damaged if dropped or crushed
	The battery may explode if exposed to open flames or other extreme sources of heat
	This side should be up
	Handle with care to avoid damage
	Keep dry
	Keep the battery away from kids
	Do not short circuit
	Do not reverse connection the positive and negative

3.2 Installation Tools

Table 3-2 Installation tool sheet

Tools	Multi-meter 	Protective gloves 	Insulated anti-smashing shoes 
	Electric screwdriver 	Cross screwdriver 	Socket spanner 
Installation Tools	Slotted screwdriver 	Wire stripper 	

3.3 Attention Items

3.3.1 Manual Custody

This manual contains important information about the Elite series batteries. A careful reading of this manual will help you become familiar with this product, and this manual should be kept in a safe place so that it can be easily accessed by maintenance personnel at any time when needed.

3.3.2 Operator Requirements

 Only trained and qualified professionals should perform various operations on the product: the product operator should be fully familiar with the product's system components and operating principles, as well as understanding the product's user manual.

3.3.3 Measuring Instrument

 In order to ensure that the electrical installation meets the requirements, please use the relevant electrical measuring equipment, such as multi-meter, power meters, etc.

4 Product Description

4.1 Product Introduction

Elite series LFP battery adopts the highest safety performance lithium iron phosphate battery, with a series of specifications of 12.8V100Ah, 12.8V200Ah, 12.8V400Ah, 25.6V100Ah, 25.6V200Ah and 51.2V100Ah. Each battery module has a built-in full-featured & high-precision battery management system (BMS), which can realize real-time monitoring of voltage, current and temperature, and has a passive balance function, which can effectively improve the battery performance.

Meanwhile 12.8V200Ah, 12.8V400Ah, 25.6V100Ah, 25.6V200Ah and 51.2V100Ah battery own special structure design, the metal strips can be used not only as a handle, but also as a “floor lock” & “rear lock”, and as a connecting strip when multiple batteries are used in combination, which can great improve installation efficiency and reduce special tools requirement, that will obviously extend the battery application fields. And unique safety design (cell, structure, bracket, aerosol automatic fire extinguishing device) can greatly improve the safety performance of the battery.

Table 4-1: Elite series battery specification

Type	Voltage(V)	Capacity(Ah)	Energy(Wh)	Width(mm)	Depth(mm)	Height(mm)	Weight(kg)
VLRV1280A	12.8	100	1280	330	172	220	11.2
VLRV2560A	12.8	200	2560	460	220	212	25
VLRV2560B	25.6	100	2560	460	220	212	27
VLRV5120A	12.8	400	5120	460	320	247	41
VLRV5120B	25.6	200	5120	460	320	247	41
VLRV5120C	51.2	100	5120	460	320	247	41

4.2 Battery Diagram

4.2.1 VLRV1280A Appearance & Dimension Schematic

Figure 4-1 VLRV1280A Appearance drawing

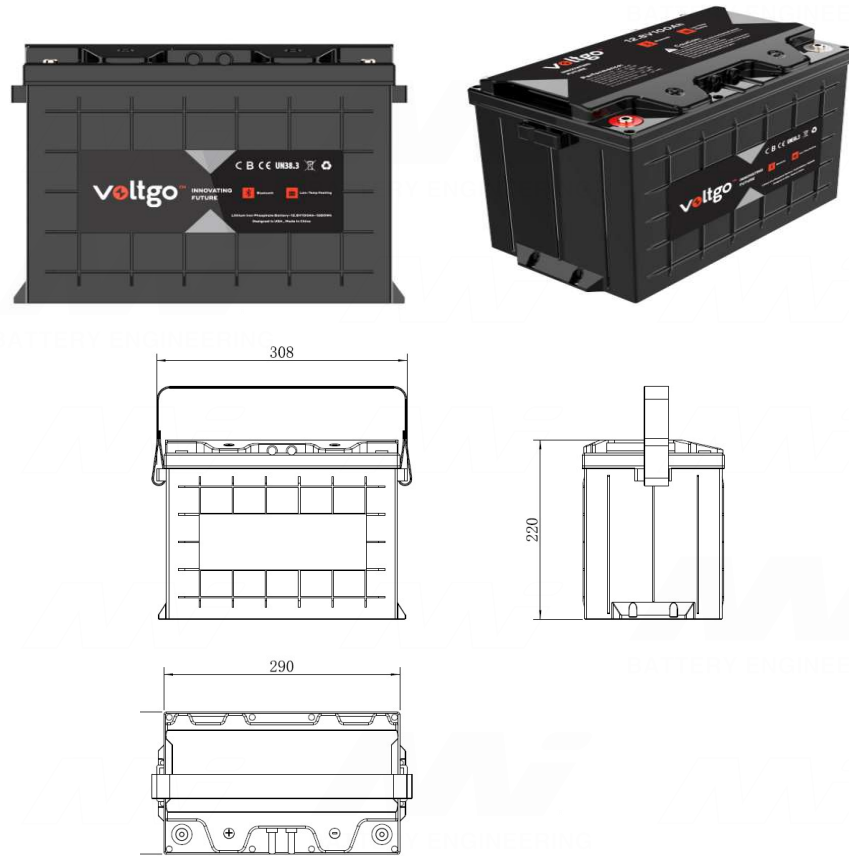

4.2.2 VLRV2560(A/B) Appearance & Dimension Schematic

Figure 4-2: VLRV2560 (A/B) Appearance drawing

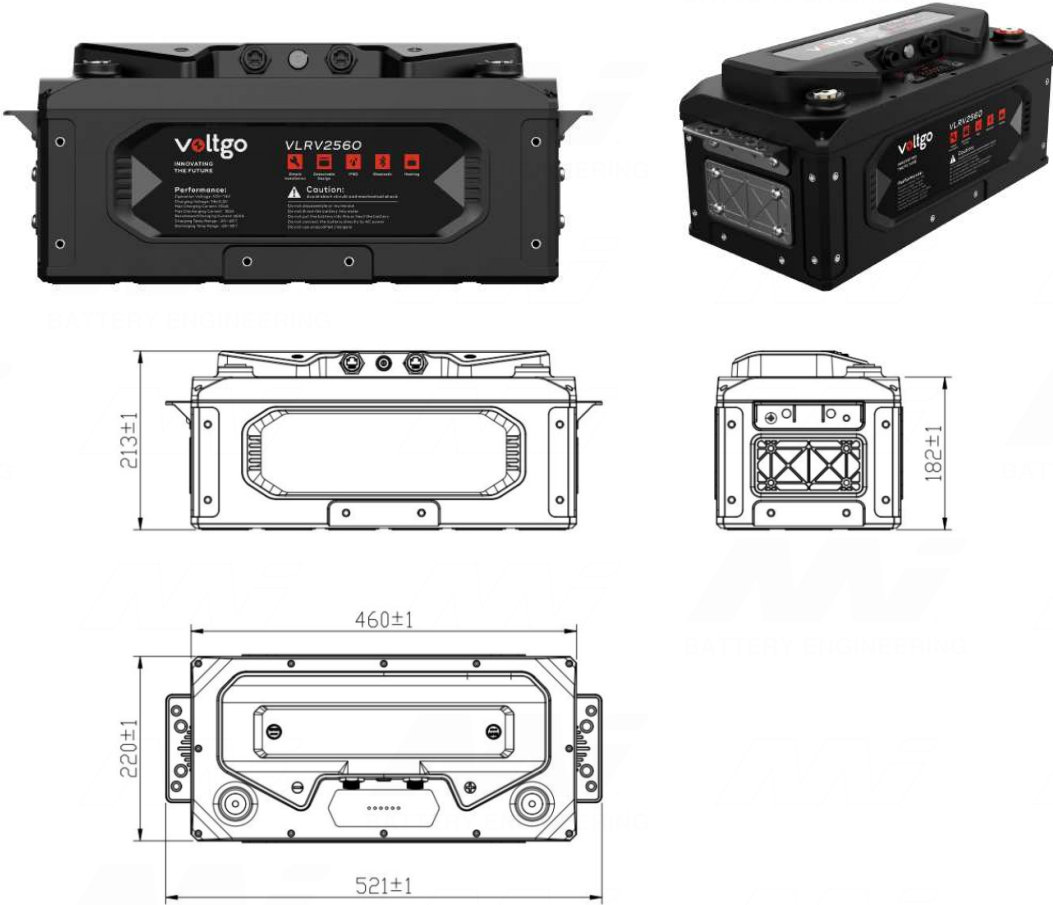

4.2.3 VLRV5120(A/B/C) Appearance & Dimension Schematic

Figure 4-3: VLRV5120 (A/B/C) Appearance drawing

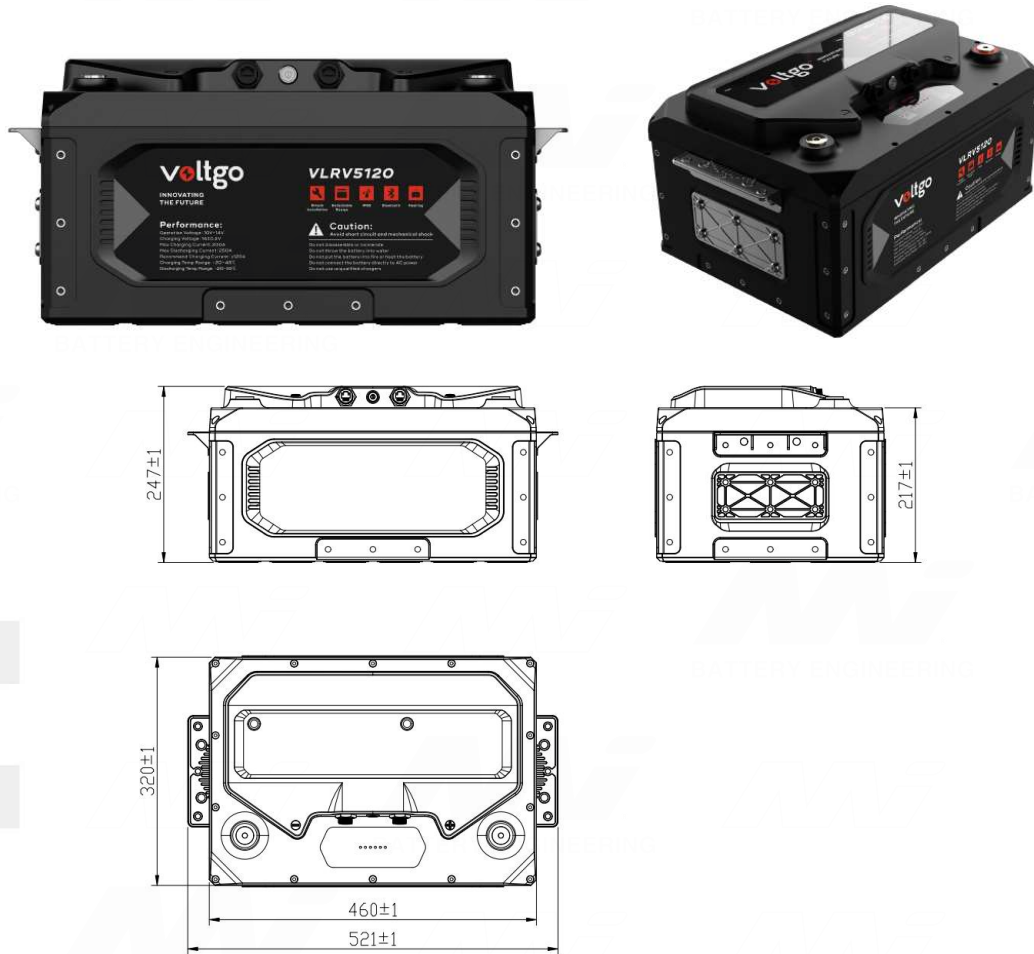

4.3 VRL2560, 5120 Series Battery Front Panel Diagram

Figure 4-4: VLRV Series Battery Front Panel

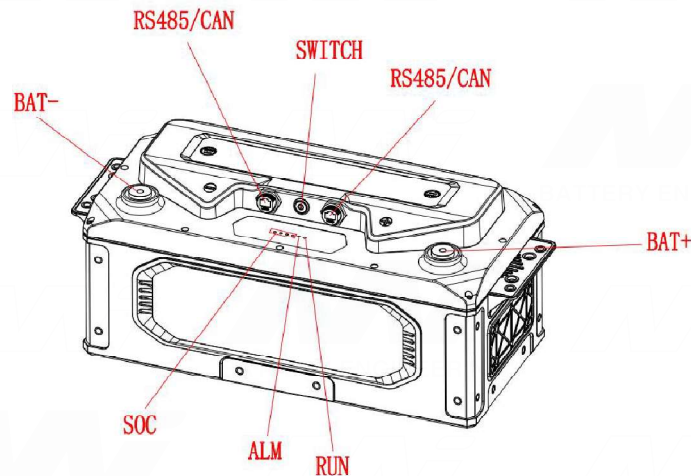

Table 4-2 VLRV 2560, 5120 series battery front panel interface description

No.	Item	Function Description	Remarks
1	BAT+	Positive terminal	M8 Screw
2	RS485/CAN	RS485/CAN Communication port	
3	Switch	Button Switch on/off the BMS	
4	BAT-	Negative terminal	M8 Screw
5	ALM	Alarming indicates LED	
6	RUN	Operating indicates LED	
7	SOC	The state of charge	4 nos green LED

4.4 VRLV2560,5120 battery LED Indicator status and definition

Table 4-3 VRLV 2560, 5120 LED indicator status and definition

Status	Normal/Alarm/Protection	RUN	ALM	SOC Indicate LED	Notes
		●	●	SOC1~SOC4●	
Shutdown / Sleep		OFF	OFF	OFF	
Stand by	Normal	ON	OFF	Based on battery indicator (Each LED indicators 25%SOC)	
Charge	Normal	Flash 1	OFF		Flash 1: OFF: 1.0S/ON: 1.0S
	Alarm	Flash 1	OFF		
	End-off Voltage	ON	OFF		
	Over-Temp Protection	OFF	ON		
Discharge	Over-current transfer limit -current	OFF	ON		
	Normal	Flash 2	OFF	Based on battery indicator	Flash 2: OFF: 0.5S/ON: 0.5S
	Alarm	Flash 2	OFF		
	End-off Voltage	OFF	ON		
Over-Temp/Over-current Protection	OFF	ON			

4.5 VRLV 2560, 5120 battery communication Port Diagram and Description

Figure 4-4 Communication interface diagram

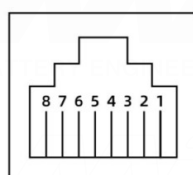

Table 4-4 VRLV 2560, 5120 series battery Communication interface definition

Pin 1	RS485 B- (T/R-)	Pin-5	CAN-L
Pin-2	RS485 A+ (T/R+)	PIN-6	/
Pin-3	/	PIN-7	RS485 A+(T/R+)
Pin-4	CAN-H	Pin-8	RS485 B-(T/R-)

5 Battery Installation

5.1 Handling, Transportation, Storage

5.1.1 Handling

Rough handling practices may cause short circuit or damage to the battery pack, resulting in battery leakage or fire.



Forklifts or carts should be used for handling.



Materials transported should not exceed the width and height of aisles and doors, and should be transported at a moderate speed.



Avoid the phenomenon of inverted and laminated battery packs when unloading.



Avoid touch the terminals when handling the battery.



Avoid battery short-circuit when handling the battery.

5.1.2 Transportation



Due to the heavy weight of the battery module, in order to guarantee safety, a forklift or multi-person handling is recommended



Avoid dropping and throwing; the equipment should be prevented from collision and strong vibration during transportation.

5.1.3 Storage



Short-term storage (within 3 months): If the battery is not used in a short period of time, the battery can be fully charged and stored in a dry, cool, non-corrosive gas, temperature 10-45°C, relative humidity 60±30%, no strong electromagnetic fields and in direct sunlight.



Long-term storage (over 3 months): If the battery is not used for more than 3 months, keep the battery SOC at 50%~70%, store it in a dry, cool, non-corrosive gas, temperature 20-35 °C, relative humidity 50 ± 15 %, in an environment without strong electromagnetic fields and direct sunlight, and make sure to charge once every 6 months to avoid irreversible capacity loss caused by long-term storage.

5.2 Battery Installation Requirement





5.2.1 Environment Requirement

Table 5-1: Environment requirement

Application scenarios	RV, solar lights, E-boat, small energy storage
Operating Environment	All-weather
Discharge Temperature (°C)	-20~55
IP grade	VLRV1280 IP65; VRLV2560,5120 IP65
Storage Temperature(°C)	10-45
Humidity (%)	5 ~ 95% RH

5.2.2 Open-box Inspection

Table 5-2: Unpacking tools sheet

Item	Tools			
Tools	Slotted screwdriver 	Protective gloves 	Stripper 	Hammer 

Elite series products have been strictly tested and tested before leaving the factory. Please sign for them after inspection. If the product is damaged, please contact the local distributor in time. Please open the box to check: whether the outer packaging is intact or damaged; whether the quantity and type of goods on the bill of materials are consistent with the description; whether the internal equipment is damaged.

5.2.3 Precautions before installation











-  Make sure every battery modules should be fully charged when used in groups.
-  Avoid moving the position or touch the contact terminals after installation unless necessary.
-  Avoid installing the battery near a heat source (such as a transformer).
-  Make sure the terminals show normal metallic luster before connecting, if the luster is dull or there are obvious traces of rust, polish the terminals with sandpaper.
-  Avoid metal conductors touching the positive and negative terminals of the battery
-  Use correct tools and appropriate method to avoid damage to the terminal, the recommended tightening torque is shown in the table

Table 5-3: Torque parameter sheet

No.	Scope of application	Tightening torque value
1	M6	8.5N*m
2	M8	12.4N*m

5.3 Battery Installation

5.3.1 VRLV1280A battery Installation and Wiring

- ① . Place the battery on a flat floor or shelf;
 - ② . Use straps to hold batteries together while multi batteries are in combination;
 - ③ . Use a wrench to connect the cable terminals to the battery terminals one by one. The torque of the wrench cannot exceed the definition in the table above. Meanwhile avoid short-circuiting the battery during the connection process.
-  All metal installation tools (such as wrenches) need to be insulated for operation
 -  Connect the battery first, then the charger or load
 -  It is recommended to keep the distance between batteries at 20mm or more
 -  After the battery is installed, it is necessary to measure the voltage of the battery pack and confirm that it is correct before it can be loaded and powered on.

5.3.2 VRLV 2560(A/B), 5120(A/B/C) battery Installation and Wiring

- ① . Place the battery on a flat floor or shelf;
- ② . Remove the "handle" on the casing, the metal part can be turned into a "ground lock", and the battery can be fixed on the floor with an electric drill; if the metal part is placed on the side of the battery, it can be turned into a "back lock", use an electric drill can attach the battery to the wall, as shown in 5-1;

Figure 5-1: VRLV2560, 5120 batteries Installation Drawing



- ③ . When multiple batteries are used in parallel, the rectangular metal strip can be used as a connecting plate, and an electric wrench is used to connect the batteries together, as shown in 5-2;

Figure 5-2: VRLV2560, 5120 batteries Installation Drawing

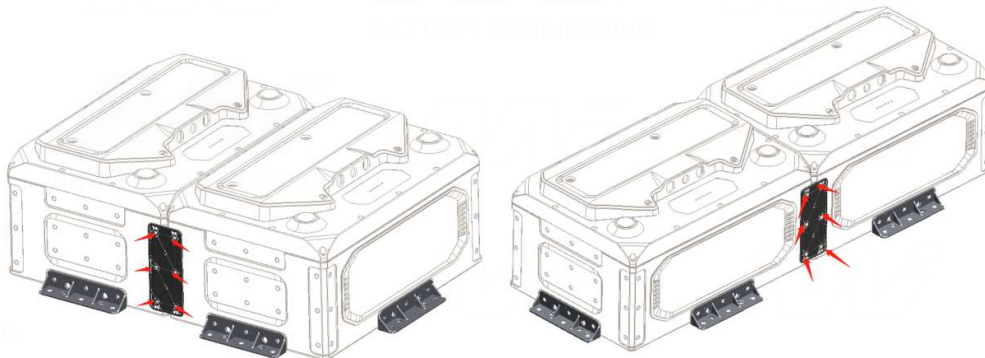

- ④ . The VRLV2560 and VRLV5120 series batteries support communication with Victron inverters via Cerbo GX and Victron Energy Ekrano GX by Victron Energy VE.Can to CAN-bus BMS type A Cable(not included) . The battery cannot directly plug into the Victron inverter. As shown in 5-3.;

Figure 5-3: VRLV 2560, 5120 Batteries Communication Cable Connection Diagram

Voltgo Elite series battery can communicate with Victron inverters via cerbo GX

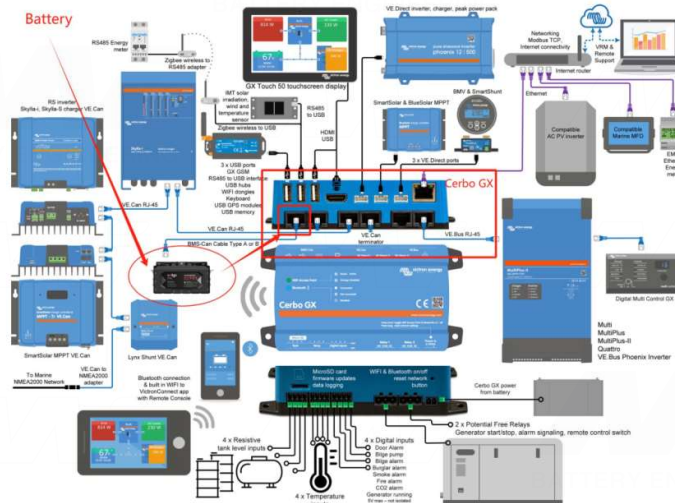
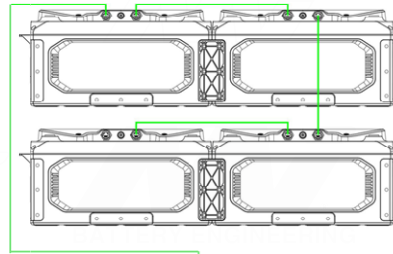

Voltgo Elite series battery can communicate with Victron inverters via Victron Energy Ekran GX

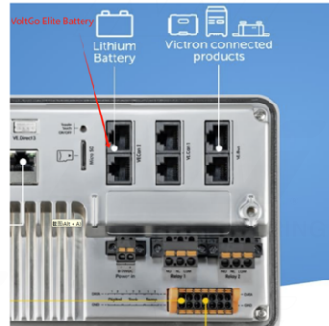

③. Parallel connect the power cable, as shown in 5-4;

Figure 5-4: VRLV2560, 5120 Batteries Power Cable Connection Diagram

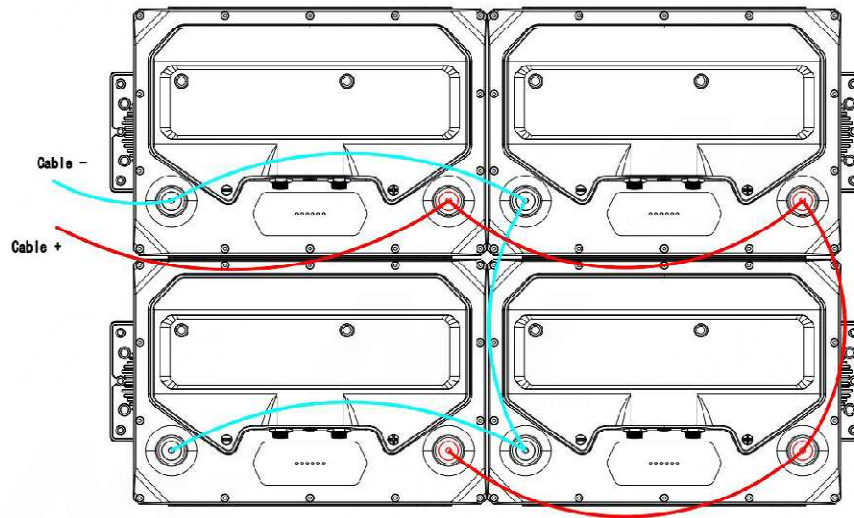

Tips:

- 1) If there is only one battery, the No.1 address battery directly connects to the inverter. And the communication port of battery connected to the corresponding inverter communication port.
- 2) If there are more than two battery modules in parallel, No.1 address battery is master battery, have to connecting to the inverter, and include power output and communication port. Others slave's batteries (other battery address) connect to each other communication port. Then all batteries and inverter can establish communication.
- 3) Ensure that the slave battery address are different from each other.
- 4) The VoltGo Elite Series VRLV1280A Battery can be connected in series with a maximum of 4 batteries or in parallel with up to 4 batteries. VoltGo Elite Series VRLV2560, 5120 series batteries do not support serial connections but can be connected in parallel to increase capacity.

6 Battery Use

If the battery needs to communicate with the inverter, the battery address and protocol need to be set through Bluetooth. If used as a lead-acid battery, it can be directly connected in parallel without action.

6.1 Battery charging

LiFePO₄ battery chargers exhibit different behavior during the charging process. Initially, the charger elevates its voltage to maintain a constant current flow. This phase, referred to as the "bulk" charging stage, allows the charger to adjust the applied voltage to supply the maximum current to the battery.

After achieving the bulk voltage, the charger progresses to the "absorption" charging stage. Here, a constant voltage—known as the "absorption voltage"—is applied.

For example, if the battery has reached 14.0 volts during constant current charging, the charger will maintain a constant voltage of 14.0 volts while gradually decreasing the charging current until it reaches the recommended charge termination voltage of around 3.5 volts per cell.

At this juncture, the battery is considered fully charged. Unlike lead-acid batteries, the self-discharge of LiFePO₄ batteries does not cause significant damage. As a result, the battery charger does not proceed to a "float" stage, as these LiFePO₄ batteries do not require continuous float charging to maintain their charge.

LiFePO₄ batteries only require those two stages of charge, including constant current charge and constant voltage charge, which is called bulk charge and absorption charge.

Table 6-1: Recommended charging parameters

Parameter	12.8V100Ah battery	25.6V100Ah battery	51.2V100Ah battery	12.8V200Ah battery	25.6V200Ah battery	12.8V400Ah battery
Bulk Voltage range (V)	14.0~14.6	28.0~29.2	56.0~58.5	14.0~14.6	28.0~29.2	14.0~14.6
Recommended Bulk Voltage (V)	14.0	28.0	56.0	14.0	28.0	14.0
Max. Bulk Current (A)	100 (1C ₁)	100 (1C ₁)	100 (1C ₁)	150 (0.75C ₁)	150 (0.75C ₁)	200 (0.5C ₁)
Recommended Bulk Current (A)	≤30 (0.3C ₁)	≤30 (0.3C ₁)	≤30 (0.3C ₁)	≤60 (0.3C ₁)	≤60 (0.3C ₁)	≤120 (0.3C ₁)
Absorption Voltage range	14.0~14.6	28.0~29.2	526.0~58.5	14.0~14.6	28.0~29.2	14.0~14.6

(V)						
Recommended Absorption Voltage (V)	14.0	28.0	56.0~58.4	14.0	28.0	14.0

6.1.1 Charge Protecting Mode - Intelligent VoltGo BMS protection function

When the battery is fully charged (14.2V), the BMS will disable the charge FETS. This will show as 100% & Protecting on the Voltgo App.

When in Protecting Mode the battery can be discharged only. The BMS will release Protecting Mode when the voltage drops below 13.6V.

Charging is allowed again after this point.



6.2 Bluetooth Setting

6.2.1 Use as a lead acid battery

- ① Download Voltgo App. Use your phone to search for Voltgo in the APP Store (IOS) or on Google Play (Android), and download the application as shown in Figure 6-1.
- ② Launch the Voltgo App on your smart phone and turn on the Bluetooth
- ③ Make sure that the battery Bluetooth is functioning by pressing the OFF/ ON switch.
- ④ On the phone screen, select the Bluetooth logo to display the devices that can be connected.
- ⑤. The Bluetooth ID is located on the side of the battery. After selecting the battery ID in the app, click "Connect". The battery information will be displayed, shown in 6-2.

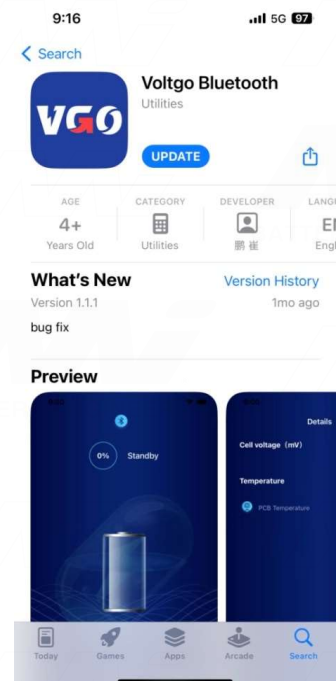
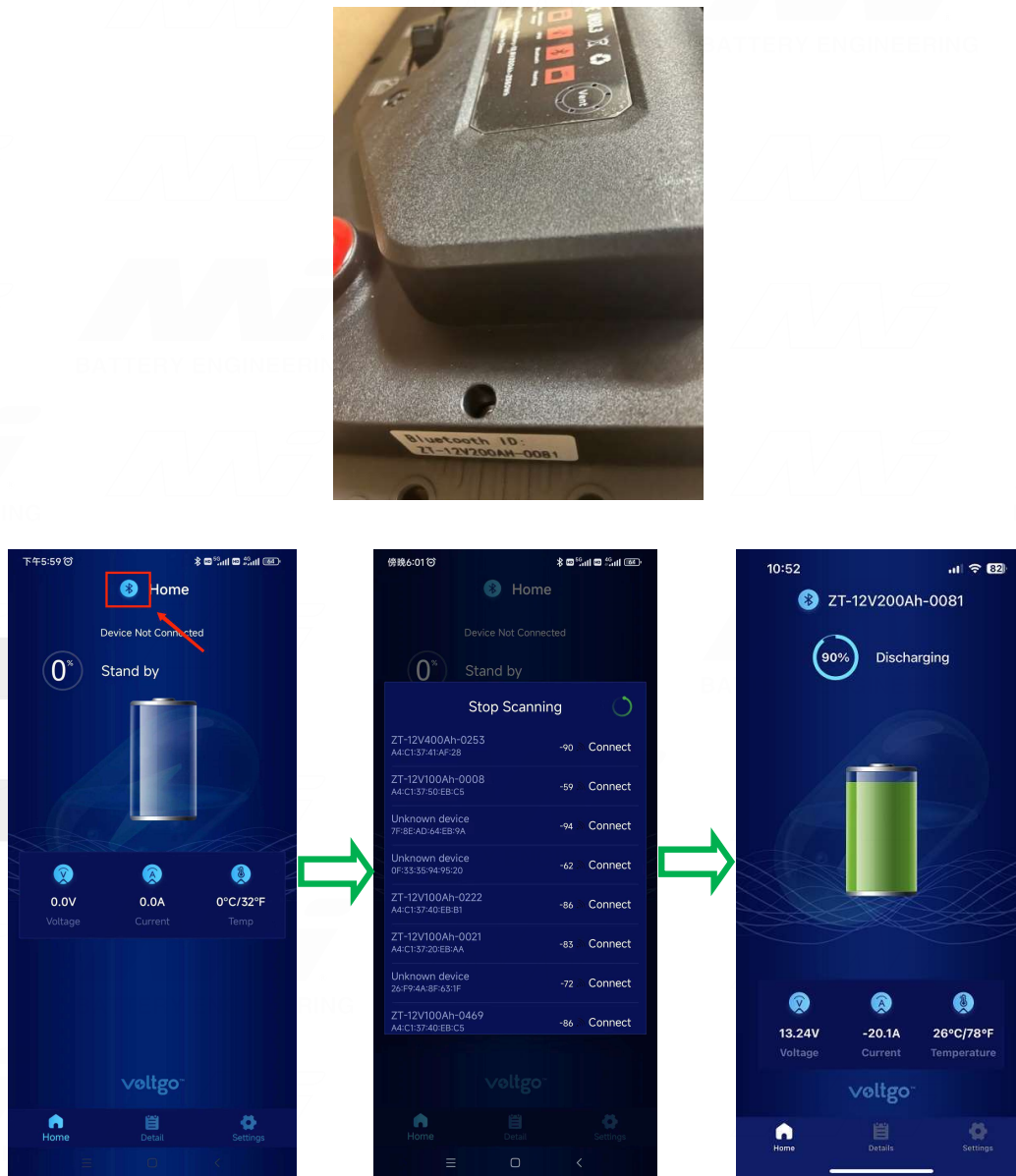

Figure 6-1 : APP Store search

Figure 6-2: APP connection



6.2.2 When battery needs to communicate with the inverter

- ① **Select ID Address.** Enter the settings interface, click on "Module ID", select the **appropriate ID** (defaults=1). Restart the battery after changed, as shown 6-3.
- ② **Select protocol.** Select corresponding protocol according to the **connected inverter**. **Reset** the battery after changed, as shown 6-3.

Figure 6-3: APP Setting

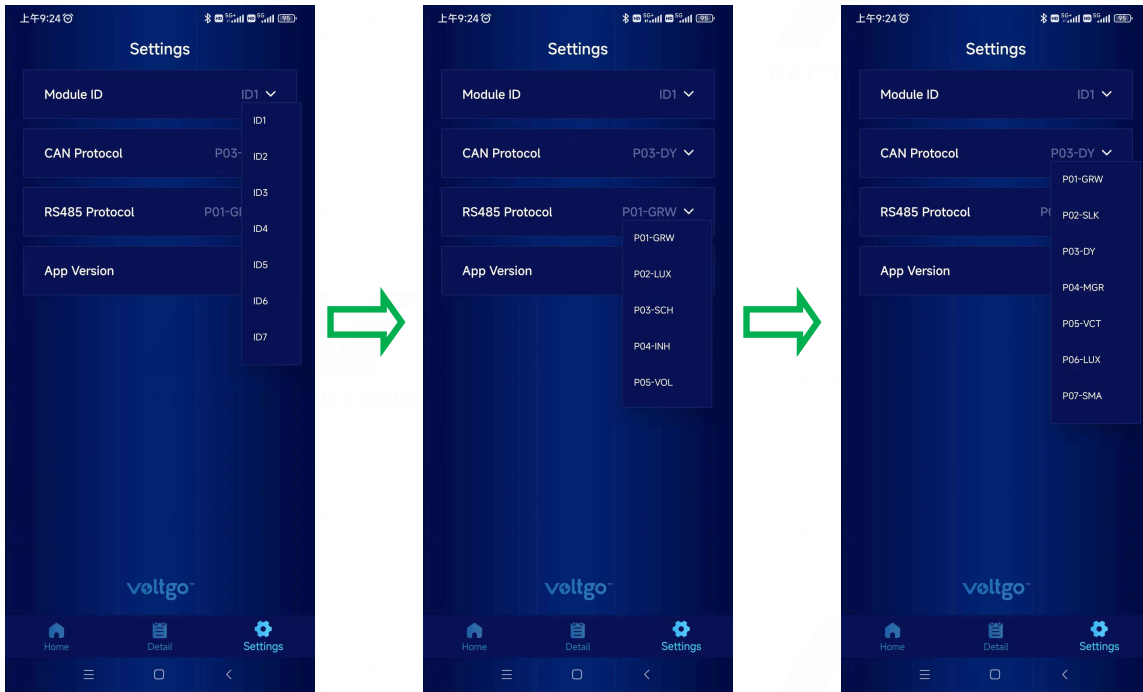

Tips: Support Inverter brand List

① For the VRLV2560A (12.8V200Ah), VRLV2560B (25.6V100Ah), VRLV5120A (12.8V400Ah) and VRLV5120 B(25.6V200Ah) series batteries, currently, communication is only supported with Victron inverters.

② For the VRLV5120C (51.2V100Ah) battery, communication is currently supported with the following inverters.

RS485		CAN			
01	Growatt	01	Growatt	09	Solis
02	Luxpower	02	Sol-Ark	10	Afore
03	Schneider	03	Deye	11	Studer
04	Inhenergy	04	Megarevo		
05	Voltronic	05	Victron		
		06	Luxpower		
		07	SMA		
		08	Inhenergy		

6.3 Supplementary Power

- ① .During transportation and storage, the battery itself will lose part of power. It is recommended to fully charge the battery before use.
- ② .If stop using within a certain period of time, it needs to be replenished regularly.
- ③ .The time interval and method of replenishment are shown in the following table

Table 6-2: Battery storage temperature and time interval for recharging

Storage Temp	Refill interval	Charging method	Remarks
≤20°C	Once/9M	14V50A CC/CV Charging to 14V, cut-off current: 5A	Only for 12.8V module
20°C~30°C	Once/6M	14V50A CC/CV Charging to 14V, cut-off current: 5A	
30°C~40°C	Once/3M	14V50A CC/CV Charging to 14V, cut-off current: 5A	
≤20°C	Once/9M	28V50A CC/CV Charging to 28V, cut-off current: 5A	Only for 25.6V module
20°C~30°C	Once/6M	28V50A CC/CV Charging to 28V, cut-off current: 5A	
30°C~40°C	Once/3M	28V50A CC/CV Charging to 28V, cut-off current: 5A	
≤20°C	Once/9M	56V30A CC/CV Charging to 56V, cut-off current: 5A	Only for 51.2V module
20°C~30°C	Once/6M	56V30A CC/CV Charging to 56V, cut-off current: 5A	
30°C~40°C	Once/3M	56V30A CC/CV Charging to 56V, cut-off current: 5A	

6.4 Battery Discharge and End-of-life Judgment

6.4.1 Battery Discharge

The BMS will automatically cut-off while the battery reaches to lower-limit voltage without human intervention. Do not continue to hang the load on the battery to avoid the over-discharge phenomenon after the battery discharge termination.

6.4.2 Capacity Test

According to the standard capacity calibration method defined in the battery specification, charged and discharged the battery, and after three cycles, the last capacity is the actual capacity. If the test temperature and test conditions are different, the capacity value may fluctuate to a certain extent.

7 Maintenance

7.1 Clean

- ① .Keep the appearance of the battery and the working environment clean and dry.
- ② .Clean the battery to avoid static electricity.
- ③ .Clean the battery with a dry cloth. Do not use gasoline, alcohol and other organic solvents, and do not use the cloth contains these substances to wipe the battery.

7.2 Common Faults (Phenomenon) and Solutions

Common faults and solutions are shown in table 7-1.



Table 7-1: Common faults (phenomenon) and solutions

NO.	Fault phenomenon	Analysis	Solution
1	Communication failure with inverter	Communication port connect error or battery ID setting error	Refer 6. Battery use
2	No DC output	Not press switch or low voltage	Press switch or charge the battery
3	Power supply time is too short	Battery capacity lack or not full power	Maintenance or replacement
4	Battery can't be charged fully	Power system DC output voltage falls below the minimum charge voltage	Regulating DC output voltage of power supply to battery suitable charging voltage
5	ALM LED always lights	Power line connection short circuit	Disconnect the power cable and check all cables
6	The battery output voltage is unstable	Battery management system do not operate normally	Press the switch to restart the battery
7	The charge and discharge capacity is insufficient	Unbalance voltage with cell	Examine/balance the cell
8	Unable to charge and discharge	BMS or cell/temperature sensor damaged	Maintenance or replacement
9	Different SOC value of batteries in parallel	Normal phenomenon	No operation

7.3 Daily Maintenance

Routine maintenance items are shown in Table 7-2 below.

Table 7-2 Routine maintenance items

Item	Maintenance Method	Maintenance intervals
<p>Power Cables</p> 	<ol style="list-style-type: none"> 1. check whether there is mechanical damage to the power cable and whether the terminal insulation sleeve has fallen off; if there is such a phenomenon, please turn off the machine and carry out maintenance or replacement. 2. check whether the power cable is loose; if there is any sign of looseness, please use a standard torque wrench to tighten it. 3. check the system for loose screws or discoloration of the copper bus bar; if the screws are loose, please tighten them with a standard torque wrench; if the copper bus bar is discolored, please contact the manufacturer for after-sales replacement. 	<p>Once every 6 month</p>
<p>Communication Cables</p> 	<ol style="list-style-type: none"> 1. check whether the parallel communication cable terminal is loose, if it is loose, re-tighten it. 2. check whether the color of the communication cable has obvious discoloration, if discoloration, please shut down the machine to replace the communication cable 	<p>Once a year</p>
<p>Cabinet Cleanliness</p>	<p>Check the cleanliness of the front door, back door and battery module inside the cabinet, if there is obvious dusty, please clean up in time.</p>	<p>Once 6-12 month</p>
<p>System running status</p> 	<ol style="list-style-type: none"> 1. check if all parameters are normal when the system is running (system voltage, current, temperature, etc.) 2. check whether the main core components of the system are normal, including system switches, contactors, etc. are normal 3. check whether the system air inlet and outlet, air ducts are normal, if there is blockage and congestion, need to clean up in time 	<p>Once every 6 month</p>
<p>Charge and discharge maintenance</p>	<p>Use light load and shallow charge/discharge to check whether the SOC, SOH status of the battery is normal (using the upper computer software to read); it is recommended that the depth of discharge and charge/discharge power should not exceed 20% of the rated value</p>	<p>Once every 6 month</p>

8 Cautions

8.1 Cautions



Please read and comply with the following conditions of installation and use of the battery, incorrect installation using the battery may cause personal injury or damage to the product.

- (1) DO NOT throw the battery into water. Please store batteries in cool and dry environment.
- (2) DO NOT put the battery into fire or heat the battery, so as to avoid explosion or other dangerous events.
- (3) When charge the battery, please choose specialized charging equipment, and follow the correct procedures, do not use unqualified chargers.
- (4) DO NOT reverse positive and negative terminals, do not connect the battery directly to AC power, avoid battery short circuit.
- (5) DO NOT using batteries from different manufacturers or different kinds, types together, and do not mix old batteries and new batteries.
- (6) DO NOT use the battery when it is hot, bulges, deforms or leaks.
- (7) DO NOT puncture the battery by nail or other sharp objects; Do not throw, stamp on, impact or hit the battery.
- (8) DO NOT open or try to repair the battery when it is defective. Warranty invalid if the battery repaired or disassembled.
- (9) Batteries are half charged before shipment, Don't use the battery if it's hot, bulge, or smell abnormal and so on, and report to after-sale dept. immediately.
- (10) If you need storage the battery for a long time, please charge and discharge the battery every three months to ensure the best performance, and the best state of charge for storage is between 50%~60%.
- (11) Please use the battery in the temperature range which defined in the manual.
- (12) The state of charge of batteries is 50% before shipment, please charge the battery before using.

8.2 Description of Warranty

We promises that during the valid warranty period of the product, any problems such as product damage or functional failure caused by non-human or intentional damage will enjoy our free repair and replacement services. Customers need to provide a valid purchase invoice or related product warranty information. If no valid proof can be provided, our company has the right to refuse to provide related services.